

Assembly Instructions

This instruction booklet contains important safety information, please read and keep for future reference.

ITEM # HID 5-D

5 DOOR CABINET

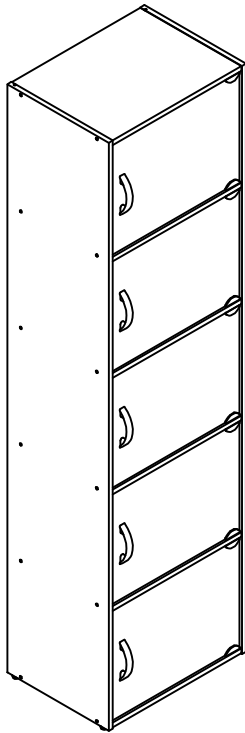

FRONT VIEW

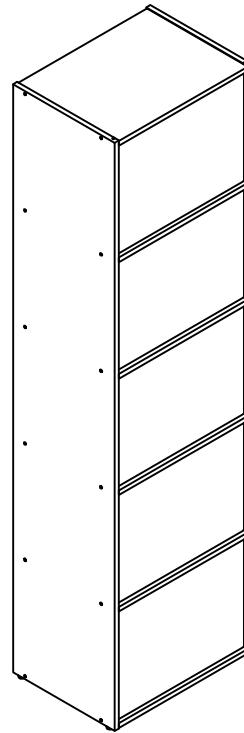

BACK VIEW

Product Dimensions: Height 59" x Width 15.9" x Depth 11.7"

Weight Capacity per shelf: 20 lbs



Mon - Fri | 9:30 am to 5pm EST

1 - 855 - HODEDAH
1 - 855 - 463 -3324



Send us an email

Support@Hodedah.com



Visit our website to open a case

www.Hodedah.com

Questions, need parts, we are here to help!

FOR PROMPT, RELIABLE SERVICE PLEASE HAVE YOUR INSTRUCTION MANUAL READY



DO NOT RETURN PRODUCT TO THE STORE

If parts are missing or damaged please contact our customer service team and we will gladly ship your replacement parts **FREE** of charge within **ONE YEAR** of purchase!

WARRANTY

Hodedah warrants this product to be free from defects in materials and workmanship and agrees to remedy any such defect. This warranty covers one year from the date of original purchase. This is solely limited to replacement of defective parts and no assembly for labor is included. This warranty does not apply to any product that has been improperly assembled, subjected to misuse, abuse or which has been altered or repaired in any way. To obtain warranty service, original purchaser must present the following; original bill of sale, date of purchase, where the product was purchased and images if applicable. Components replaced warranted through the remainder of the original warranty only. The defective part will be replaced without charge, subject to the terms and conditions described above.

WARNING

- This product contains small parts, keep away from children.
- This product contains plastic bags, keep away from children.
- Serious or fatal crushing injuries can occur from furniture tip-over. To help prevent this, place heaviest items on the lower shelves and drawers. Do not set heavy objects on top shelves and drawers.
- Never allow children to climb or hang on drawers, shelves and doors.

- Never open more than one drawer at a time.
- The use of tip-over restraints may reduce but not eliminate the risk of tip-over.

Let's get started...

Helpful hints, read before beginning assembly

- Make sure you receive all boxes. If your item is packed in one box, box count will read 1 of 1, likewise if your item is packed in two boxes, box count will read 1 of 2 and second box will read 2 of 2.
- Read each step carefully. It is very important that each step is performed in the correct order. If these steps are not followed in sequence, assembly difficulties will occur.
- Work in a spacious level area, preferably carpet, near the place the unit will be used.
- **DO NO USE** power tools to assemble your furniture, it will strip and damage parts.
- Your package should include the following hardware and parts. Parts are labeled or stamped on the raw edge. Please inspect contents to ensure you have received all components. **If you are missing any hardware or parts please contact customer service right away before assembly.**

Assembly Tools Required (not supplied)

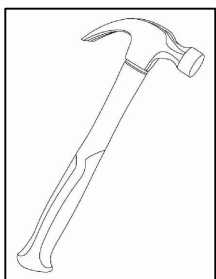

Hammer

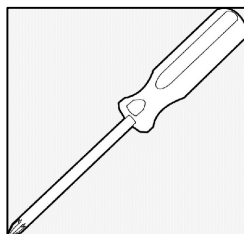

Phillips Screwdriver



Tape Measure











No Power Tools Needed

Product Care and Maintenance

- Wipe clean with dry soft cloth, never use chemicals or cleaning products they will damage the finish.
- Avoid placing your furniture in direct sunlight, as sunlight causes fading.
- Never push, drag or pull your furniture, to move to a new location carefully with two or more people carry the unit to its new location.
- Avoid extreme changes in temperature by arranging furniture away from radiators, heat and air vents and air conditioning units.

Hardware List

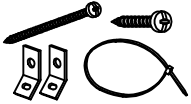
<p>A </p> <p>JCBCW M5 x 40mm SCREW</p>	<p>QTY</p> <p>24</p>	<p>B </p> <p>M4 x 25mm CSK SCREW</p>	<p>QTY</p> <p>10</p>	<p>C </p> <p>M3.5 x 12mm CSK SCREW</p>	<p>QTY</p> <p>15</p>
<p>D </p> <p>PVC NAIL</p>	<p>4</p>	<p>E </p> <p>AC58 - 100 - 64</p>	<p>5</p>	<p>F </p> <p>MAGNET</p>	<p>5</p>
<p>G </p> <p>PLATE</p>	<p>5</p>	<p>H </p> <p>DOOR HOLDER (12mm)</p>	<p>10</p>	<p>I </p> <p>ALLEN KEY</p>	<p>1</p>
<p>J </p> <p>ANTI-TIP KIT</p>	<p>2</p>				

Important

1. Before you throw the package, please use the Check Box to identify the parts and hardware to ensure that you have everything you need.
2. Check and measure the bolts before applying them to parts.
3. Do not completely tighten all hardware until the entire assembly is complete, unless indicated otherwise.

Part List

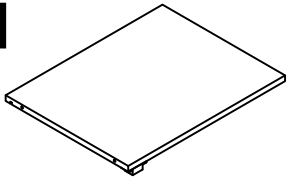
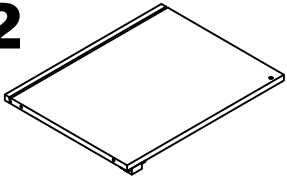
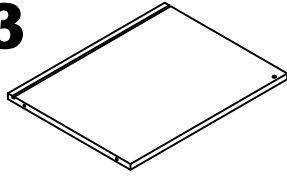
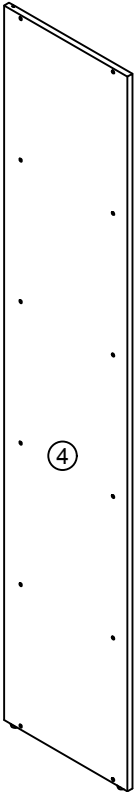
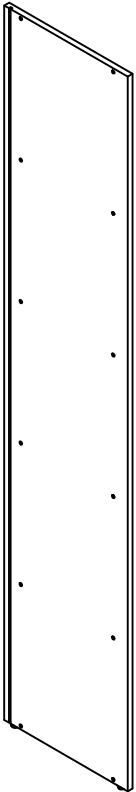
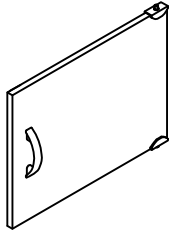
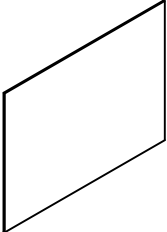
<p>1</p> 	<p>QTY 1</p>	<p>2</p> 	<p>QTY 4</p>	<p>3</p> 	<p>QTY 1</p>
<p>4</p> 	<p>1</p>	<p>5</p> 	<p>1</p>	<p>6</p> 	<p>5</p>
<p>7</p> 	<p>5</p>				

The Breakdown

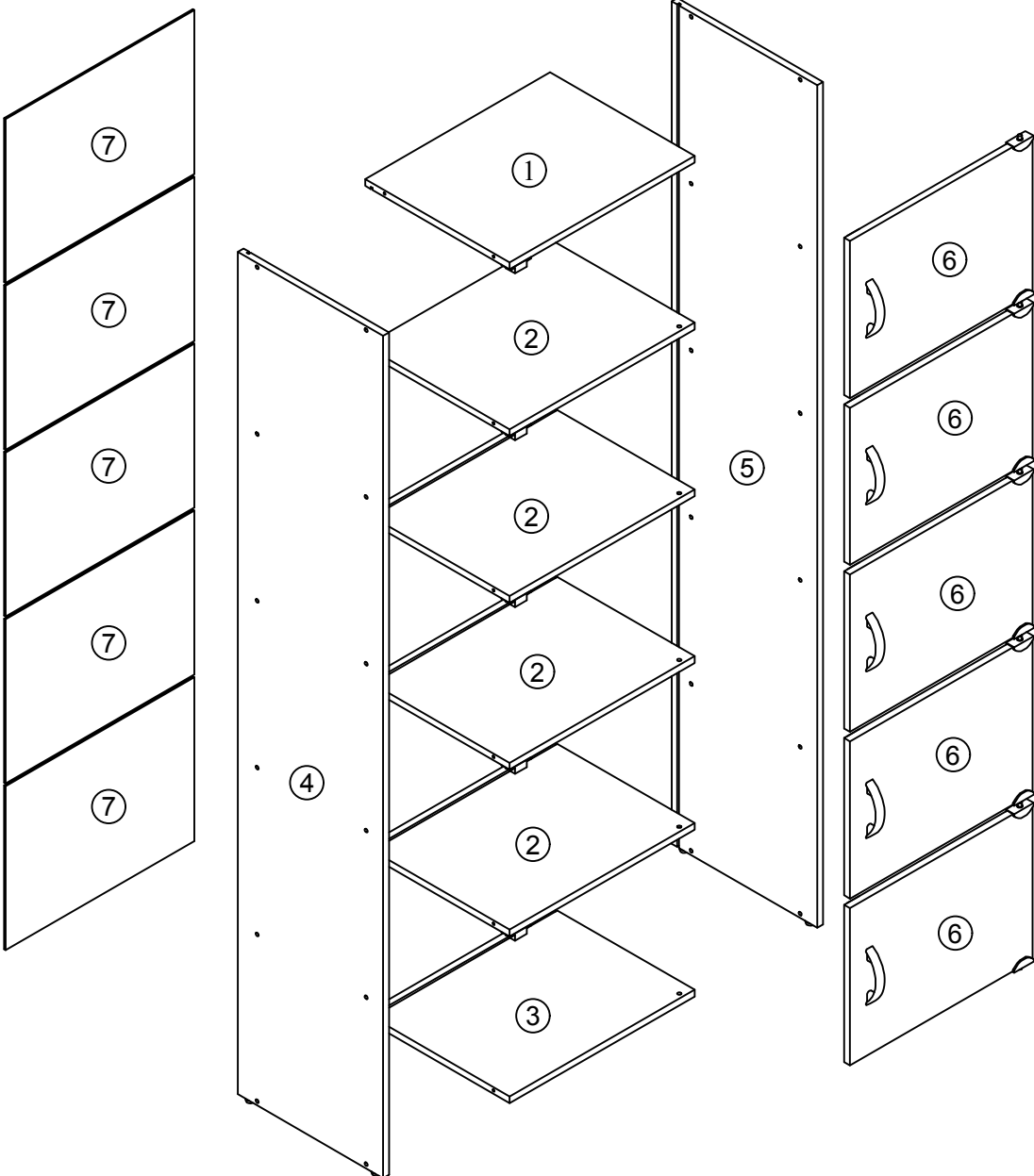

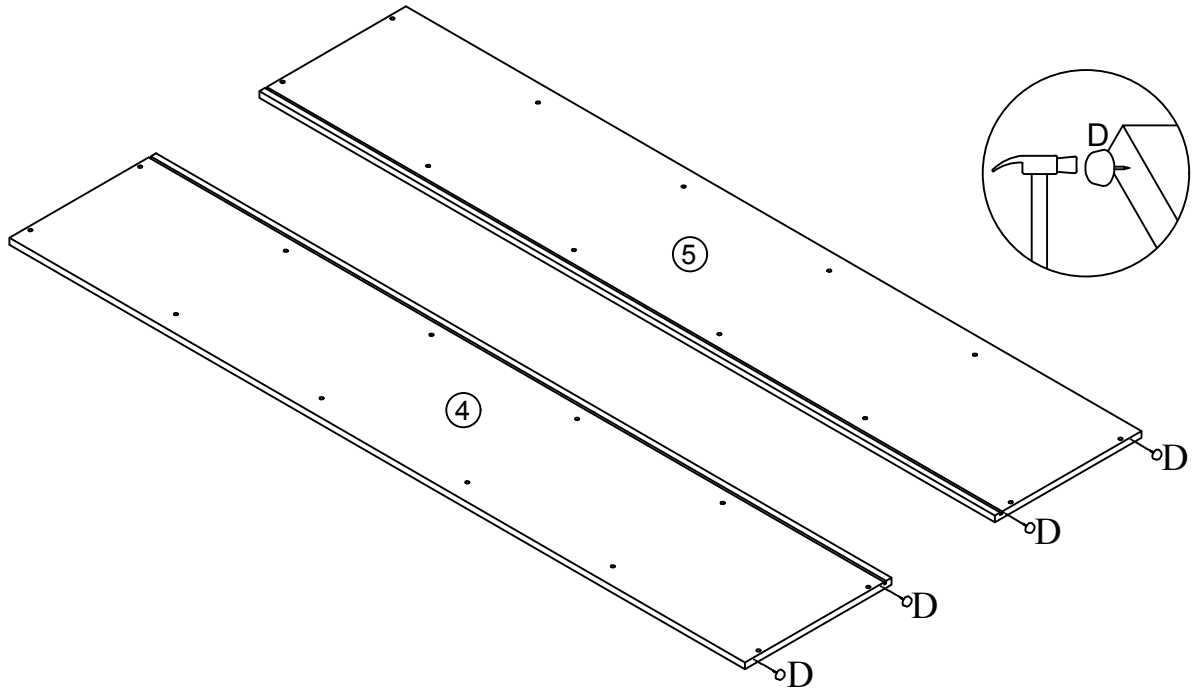

Step 1

D		PVC NAIL	4
---	---	----------	---



- Fix 4 x Pvc Nails (D) into panels (4) & (5) using a Hammer.

Step 2

A		JCBCW M5 x 40mm SCREW	12
I		ALLEN KEY	1

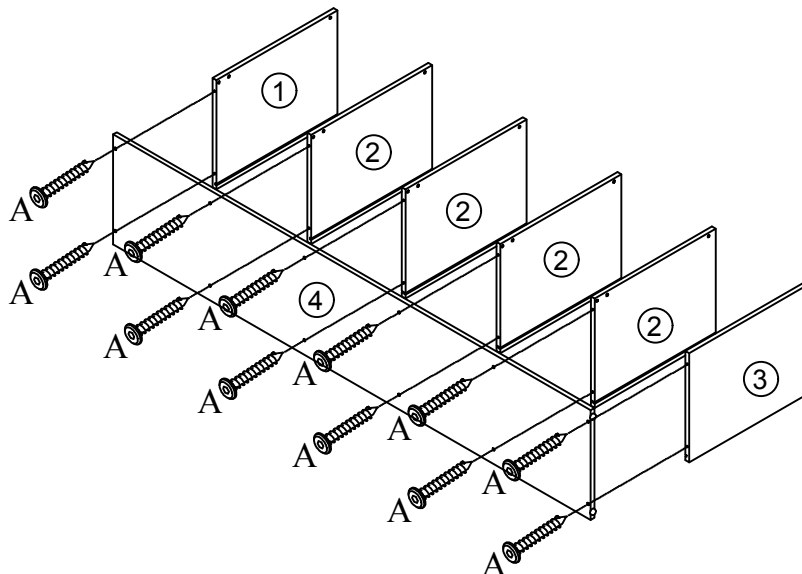

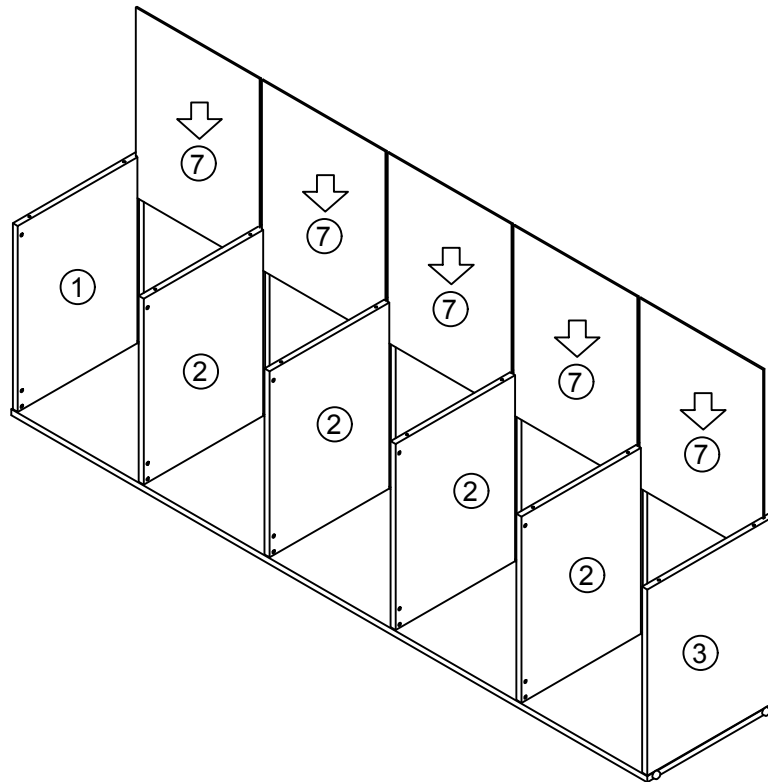

- Attach panel (4) to panels (1) , (2) , (3).
- Insert 12 x JCBCW Screw (A) to panel (4) and tighten with a Allen Key (I).

Step 3



- Slide panels (7) into the groove of panels (1) , (2) , (3).

Step 4



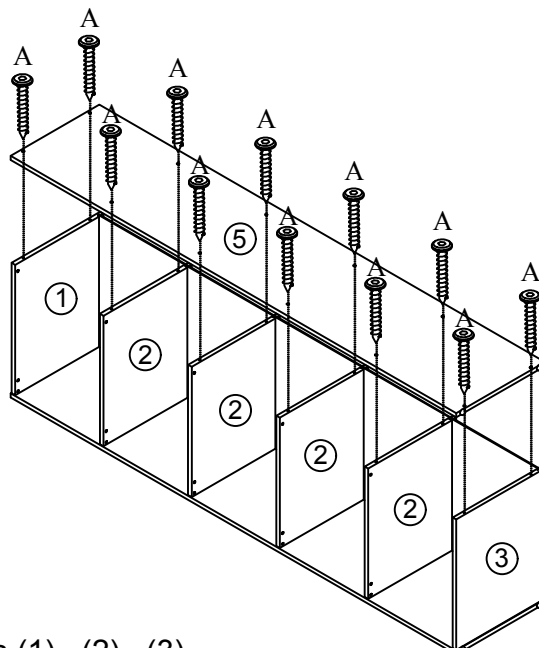

A	 JCBCW M5 x 40mm SCREW	12
I	 ALLEN KEY	1



- Attach panel (5) to panels (1) , (2) , (3).
 - Insert 12 x JCBCW Screw (A) to panel (5) and tighten with a Allen Key (I).

Step 5

Almost there

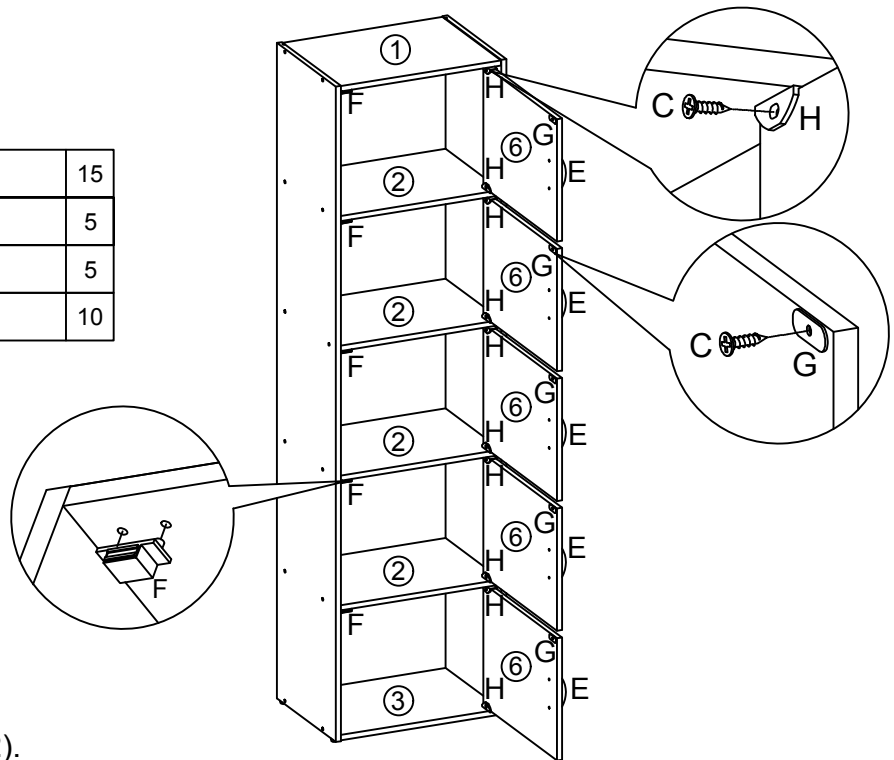

C	 M3.5 x 12mm CSK SCREW	15
F	 MAGNET	5
G	 PLATE	5
H	 DOOR HOLDER (12mm)	10



- Fix Magnet (F) to panels (1) & (2).
- Insert 10 x Door Holder (H) to panels (1) , (2) , (3).
- Fix panels (6) to Door Holder (H) with 10 x CSK Screw (C) using a Phillips head screwdriver.
- Fix Plate (G) to panels (6) with 5 x CSK Screw (C) using a Phillips head screwdriver.

Step 6

Final step

B	 M4 x 25mm CSK SCREW	10
E	 AC58 - 100 - 64	5

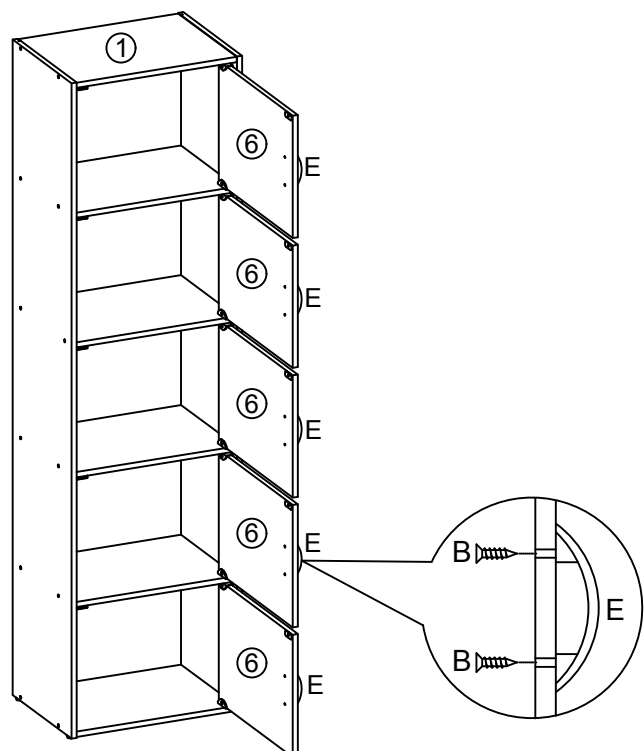

- Attach Handle (E) to panels (6) with 10 x CSK Screw (B) using a Phillips head screwdriver.

FITTING OF ANTI-TIP SAFETY STRAP

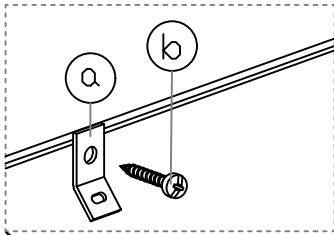

STEP 1:

- Attach the mounting bracket (a) to the furniture in the solid part below the top panel a few inches away from the side of the unit.
- Screw (b) through the smallest hole of (a).

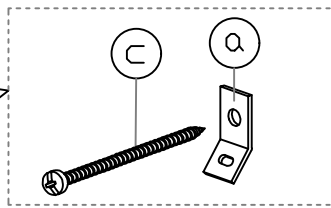
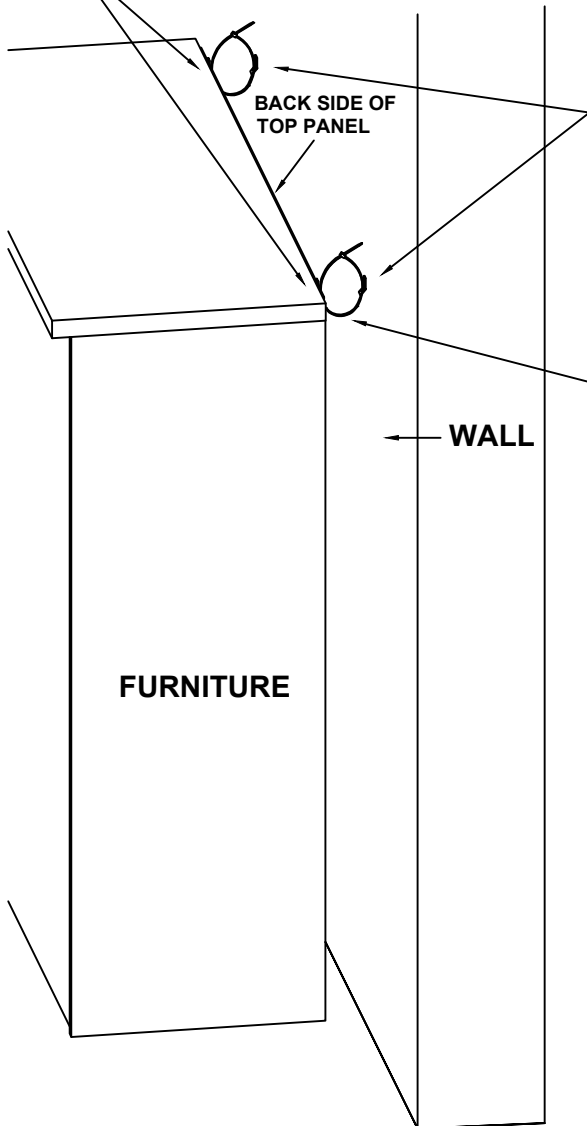

STEP 2:

- Locate a stud in the wall behind the unit, does not have to be centered.
- Place the other mounting bracket (a) on the wall stud 2 inches below the mounting bracket secured to the back of your unit.
- Attach to the wall stud using (c) through the smaller hole of (a).

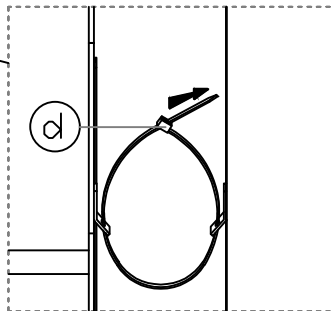

STEP 3:

- Repeat the same step a few inches away from the other side of the unit.
- Place the furniture into position so both mounting brackets are vertically in line.
- Lace the end of the restraint strap through the larger holes in each mounting bracket.
- Secure the straps and lock into place.

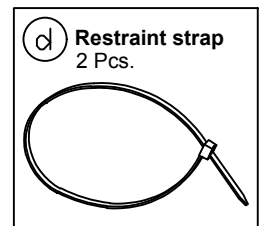
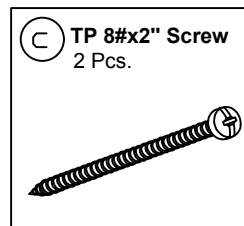
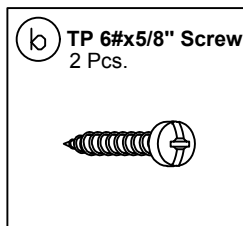
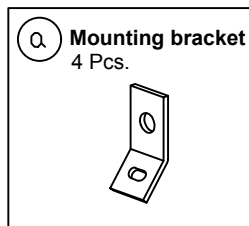

HODEDAH®

Job Complete

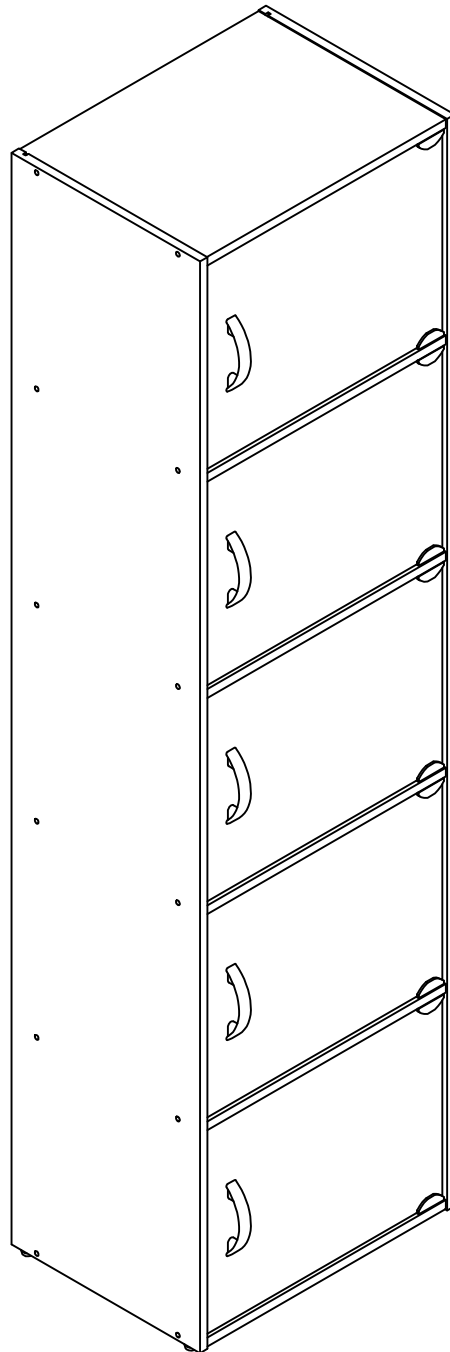

Enjoy & Thank you for purchasing from Hodedah!

