

HODEDAH®

Assembly Instructions

This instruction booklet contains important safety information, please read and keep for future reference.

ITEM # HI425-G

NIGHT TABLE

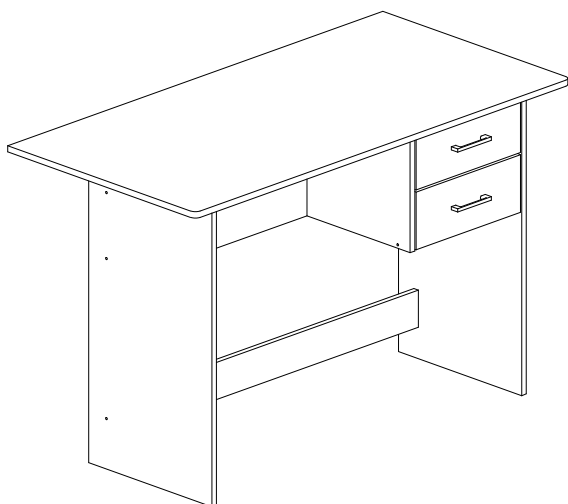

FRONT VIEW

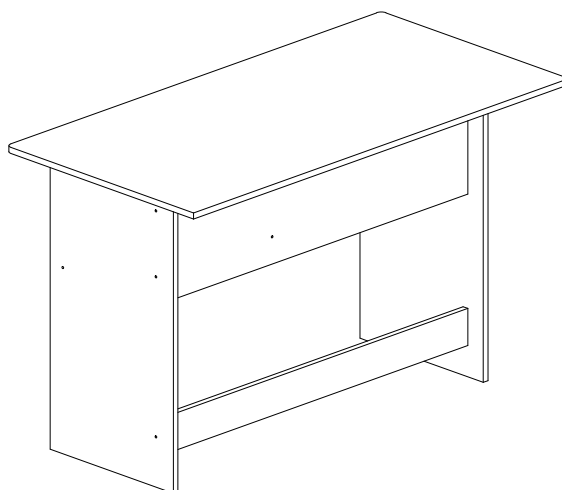

BACK VIEW

Product Dimensions: Height 29.52" x Width 47.24" x Depth 23.62"

Weight Capacity Per Drawer 15lbs

HODEDAH®



Phone

Mon - Fri | 9:30 am to 5pm EST

1 - 855 - HODEDAH

1 - 855 - 463 -3324



Email

Send us an email

Support@Hodedah.com



Website

Visit our website to open a case

www.Hodedah.com

Questions, need parts, we are here to help!

FOR PROMPT, RELIABLE SERVICE PLEASE HAVE YOUR INSTRUCTION MANUAL READY



DO NOT RETURN PRODUCT TO THE STORE

If parts are missing or damaged please contact our customer service team and we will gladly ship your replacement parts FREE of charge within **ONE YEAR** of purchase!

WARRANTY

Hodedah warrants this product to be free from defects in materials and workmanship and agrees to remedy any such defect. This warranty covers one year from the date of original purchase. This is solely limited to replacement of defective parts and no assembly for labor is included. This warranty does not apply to any product that has been improperly assembled, subjected to misuse, abuse or which has been altered or repaired in any way. To obtain warranty service, original purchaser must present the following; original bill of sale, date of purchase, where the product was purchased and images if applicable. Components replaced warranted through the remainder of the original warranty only. The defective part will be replaced without charge, subject to the terms and conditions described above.

WARNING

- This product contains small parts, keep away from children.
- This product contains plastic bags, keep away from children.
- Serious or fatal crushing injuries can occur from furniture tip-over. To help prevent this, place heaviest items on the lower shelves and drawers. Do not set heavy objects on top shelves and drawers.
- Never allow children to climb or hang on drawers, shelves and doors.
- Never open more than one drawer at a time.
- The use of tip-over restraints may reduce but not eliminate the risk of tip-over.

HODEDAH®

- Never open more than one drawer at a time.
- The use of tip-over restranits may reduce but not eliminate the risk of tip-over.

Let's get started...

Helpful hints, read before beginning assembly

- Make sure you receive all boxes. If your item is packed in one box, box count will read 1 of 1, likewise if your item is packed in two boxes, box count will read 1 of 2 and second box will read 2 of 2.
- Read each step carefully. It is very important that each step is performed in the correct order. If these steps are not followed in sequence, assembly difficulties will occur.
- Work in a spacious level area, preferably carpet, near the place the unit will be used.
- **DO NO USE** power tools to assemble your furniture, it will strip and damage parts.
- Your package should include the following hardware and parts. Parts are labeled or stamped on the raw edge. Please inspect contents to ensure you have received all components. **If you are missing any hardware or parts please contact customer service right away before assembly.**

Assembly Tools Required (not supplied)

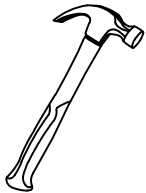

Hammer

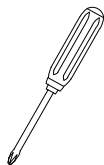

Phillips Screwdriver

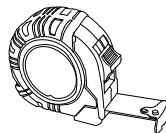

Tape Measure

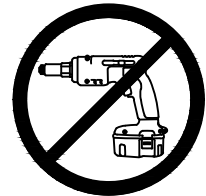









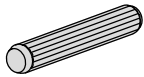
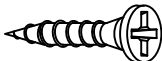

No Power Tools Needed



Product Care and Maintenance

- Wipe clean with dry soft cloth, never use chemicals or cleaning products they will damage the finish.
- Avoid placing your furniture in direct sunlight, as sunlight causes fading.
- Never push, drag or pull your furniture, to move to a new location carefully with two or more people carry the unit to its new location.
- Avoid extreme changes in temperature by arranging furniture away from radiators, heat and air vents and air conditioning units.

Hardware List

<p>1</p>  <p>Pvc Dowel</p>	<p>QTY</p> <input type="checkbox"/> 25 Pcs	<p>2</p>  <p>M3x16mm Screw</p>	<p>QTY</p> <input type="checkbox"/> 2 Pcs	<p>3</p>  <p>Screw M3.5 x 14mm *For # 13 Drawer Slides</p>	<p>QTY</p> <input type="checkbox"/> 16 Pcs
<p>4</p>  <p>Screw M4 x 32mm</p>	<p>QTY</p> <input type="checkbox"/> 8 Pcs	<p>5</p>  <p>Screw M6.2 x 10mm *For # 12 Drawer Slides</p>	<p>QTY</p> <input type="checkbox"/> 8 Pcs	<p>6</p>  <p>Screw M6 x 40mm</p>	<p>QTY</p> <input type="checkbox"/> 10 Pcs
<p>7</p>  <p>Pvc Cap</p>	<p>QTY</p> <input type="checkbox"/> 10 Pcs	<p>9</p>  <p>Mini Fix Pvc Cap</p>	<p>QTY</p> <input type="checkbox"/> 10 Sets 10 Pcs	<p>10</p>  <p>Backply Stopper</p>	<p>QTY</p> <input type="checkbox"/> 2 Pcs
<p>11</p>  <p>Nail</p>	<p>QTY</p> <input type="checkbox"/> 15 Pcs	<p>14</p>  <p>Allen Key</p>	<p>QTY</p> <input type="checkbox"/> 1 Pc		

Accessories

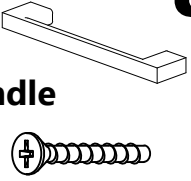
 <p>* Fix On Side Panels (A)</p> <p>* Fix On Side Panels (F)</p>	<p>12</p> <p>Drawer Slide - A</p> <p>*Fix On Side Panels (A) (F)</p>	<p>QTY</p> <p><input type="checkbox"/></p> <p>2 Sets</p>
 <p>* Fix On Drawer Side Panels (J)</p> <p>* Fix On Drawer Side Panels (K)</p>	<p>13</p> <p>Drawer Slide - B</p> <p>*Fix On Side Panels (J) (K)</p>	<p>QTY</p> <p><input type="checkbox"/></p> <p>2 Sets</p>
 <p>8</p> <p>Handle</p> <p>Screw M4 X 20mm</p>	<p>QTY</p> <p><input type="checkbox"/></p> <p>2 Pcs</p> <p>4 Pcs</p>	

Important

1. Before you throw the package, please use the Check Box to identify the parts and hardware to ensure that you have everything you need.
2. Check and measure the bolts before applying them to parts.
3. Do not completely tighten all hardware until the entire assembly is complete, unless indicated otherwise.

Parts List

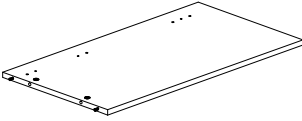
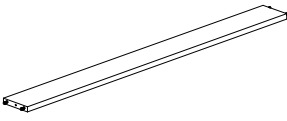
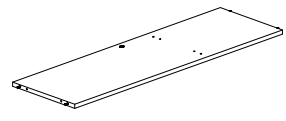
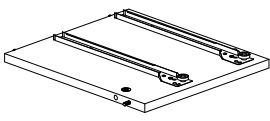
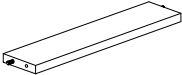
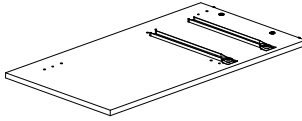
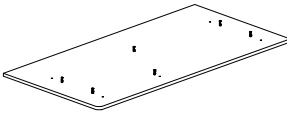
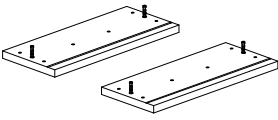
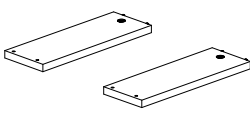
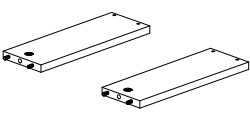
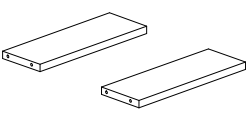
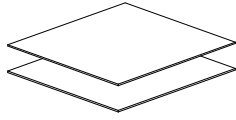
<p>A Left Side Panel 735 x 394 x 15mm</p> 	<p>QTY</p> <p>1 Pc</p>	<p>B Back Strengthening Panel 976 x 90 x 15mm</p> 	<p>QTY</p> <p>1 Pc</p>	<p>C Back Panel 976 x 292 x 15mm</p> 	<p>QTY</p> <p>1 Pc</p>
<p>D Stand Panel 292 x 330 x 15mm</p> 	<p>QTY</p> <p>1 Pc</p>	<p>E Front Strengthening Panel 342 x 76 x 15mm</p> 	<p>QTY</p> <p>1 Pc</p>	<p>F Right Side Panel 735 x 394 x 15mm</p> 	<p>QTY</p> <p>1 Pc</p>
<p>G Top Panel 1200 x 600 x 15mm</p> 	<p>QTY</p> <p>1 Pc</p>	<p>H Drawer Front Panel 334 x 140 x 15mm</p> 	<p>QTY</p> <p>2 Pcs</p>	<p>I Left Drawer Side Panels 292 x 102 x 15mm</p> 	<p>QTY</p> <p>1 Pc</p>
<p>J Right Drawer Side Panels 292 x 102 x 15mm</p> 	<p>QTY</p> <p>2 Pcs</p>	<p>K Drawer End Panels 287 x 100 x 15mm</p> 	<p>QTY</p> <p>2 Pcs</p>	<p>L Drawer Base Panels 315 x 296 x 3mm</p> 	<p>QTY</p> <p>2 Pcs</p>

HODEDAH®

The Breakdown

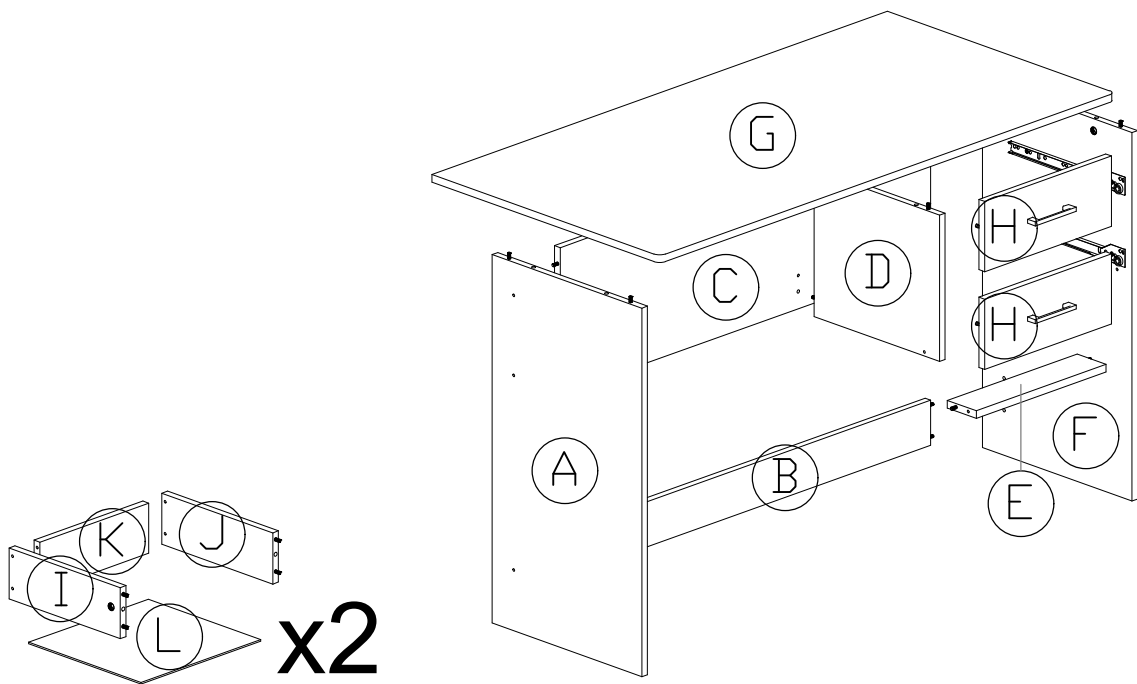

HODEDAH®

Step 1

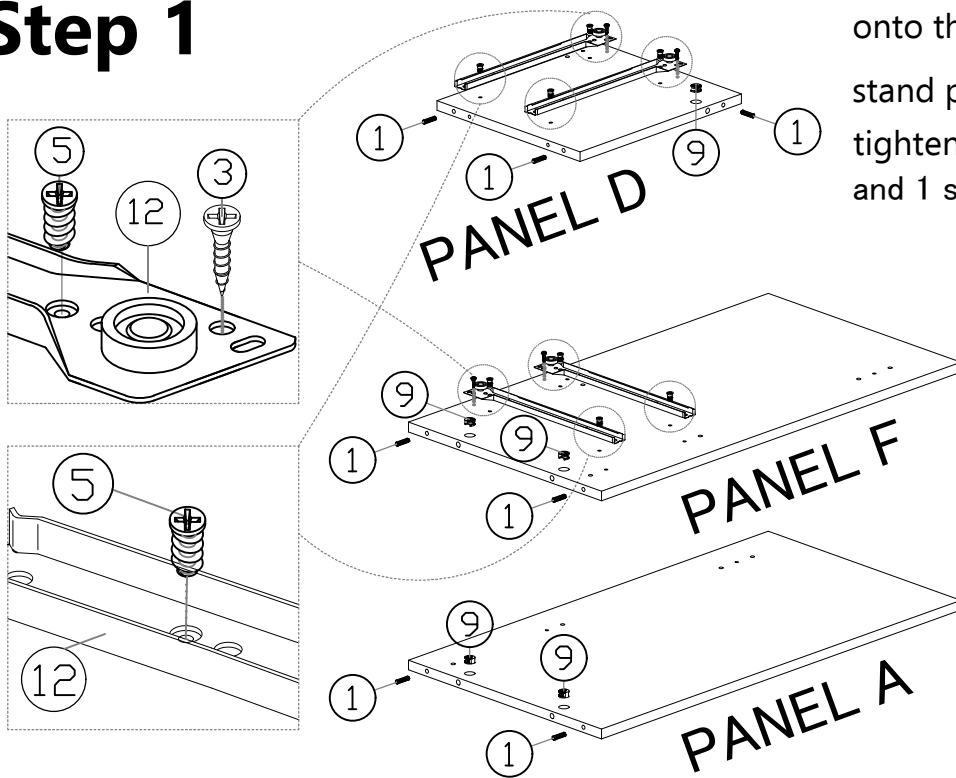

A. Place the drawer slide A ⑫ onto the 2 holes area shown at stand panel **D** and **F**. Then tighten it with 2 screws ⑤ and 1 screw ③.

B. Insert the mini fix ⑨ (nuts) with the cross arrow mark facing upward and aim to panel **A, C, D** & **F**'s top thru holes. (As shown)

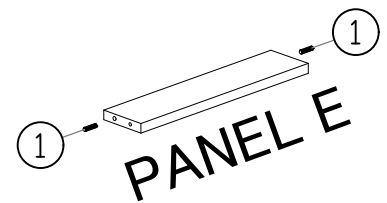

C. Insert the PVC dowels ① to panel **A, B, C, D, E** and **F**'s non-thru holes as shown, using hammer to tap them in.

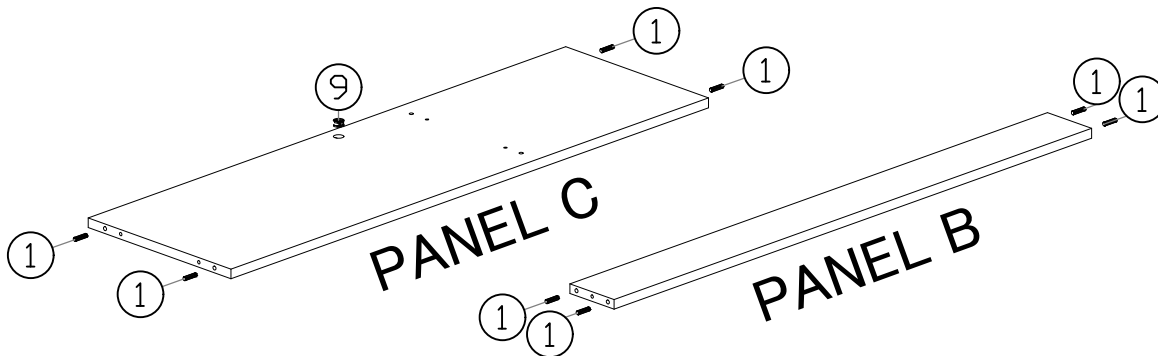

D. Insert, push down and tighten mini fix screw ⑨, to the hole as shown (Panel **G**)

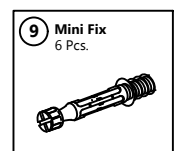
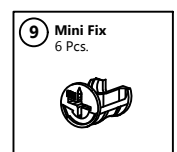
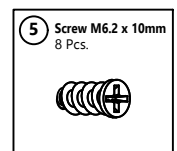
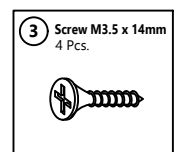
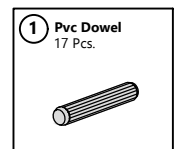
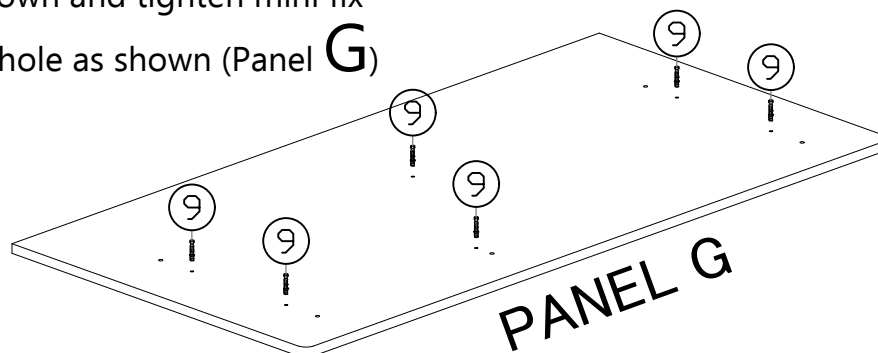

HODEDAH®

Step 2

Fix Panel **E** onto Panels **F** by inserting the dowels onto the non-thru holes at Panel **F**.

Next, fix Panel **D** onto panel **E** by inserting the dowels onto the non-thru holes at Panel **D**.

Use allen key ⑭ to tighten 2 screw ⑥ from the thru-holes of panel **D** and **F** to non-thru hole of panels **E** as shown.

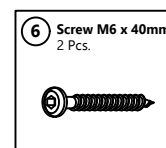
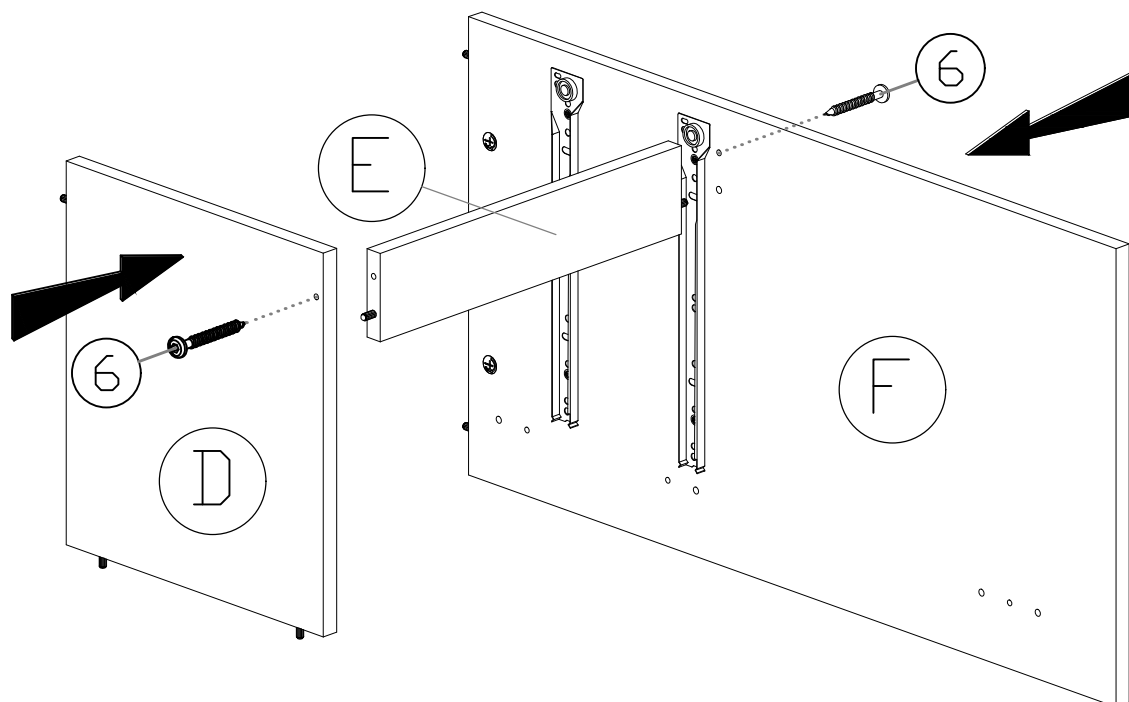

HODEDAH®

Step 3

Fix Panel **B**, **C** & **E** onto Panels **F** by inserting the dowels onto the non-thru holes at Panel **F**.

Next, fix Panel **A** onto panel **B** & **C** by inserting the dowels onto the non-thru holes at Panel **A**.

Use allen key ⑭ to tighten 8 screws ⑥ from the thru-holes of panel **A**, **C** and **F** to non-thru hole of panels **B** & **C** as shown.

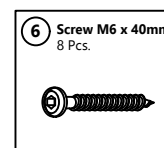
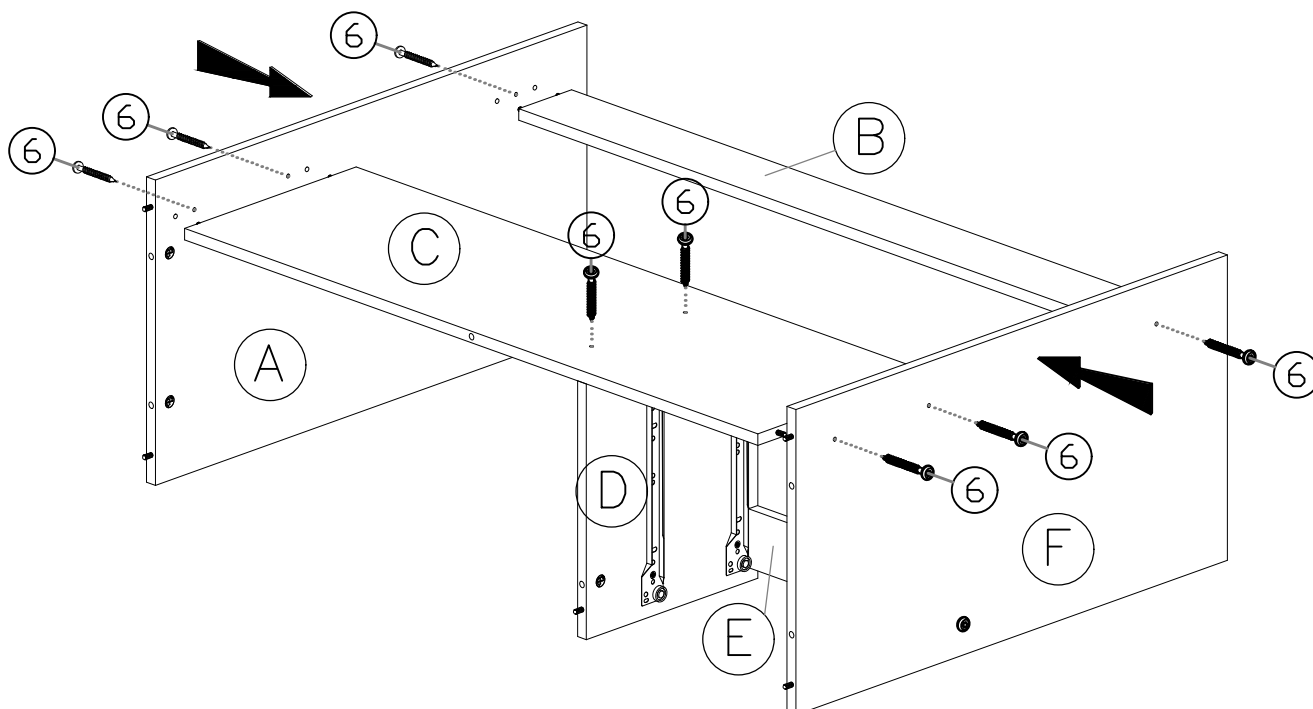

Step 4

-Fix panel **G** onto panels **A, C, D & F** and align properly by inserting the 4 dowels of panels A & F onto the non thru holes of panel G.

-Pushing and light tapping of panel **G** to have panel **A, G & F** fix tightly.

-Then, tighten mini fix ⑨ clockwise to lock the mini fix up for tightening panel

G up. Cover 4 mini fix caps provided by pushing the cover 's stem onto the hole of mini fix nut on upper side of panel

A, C, D and **F**.

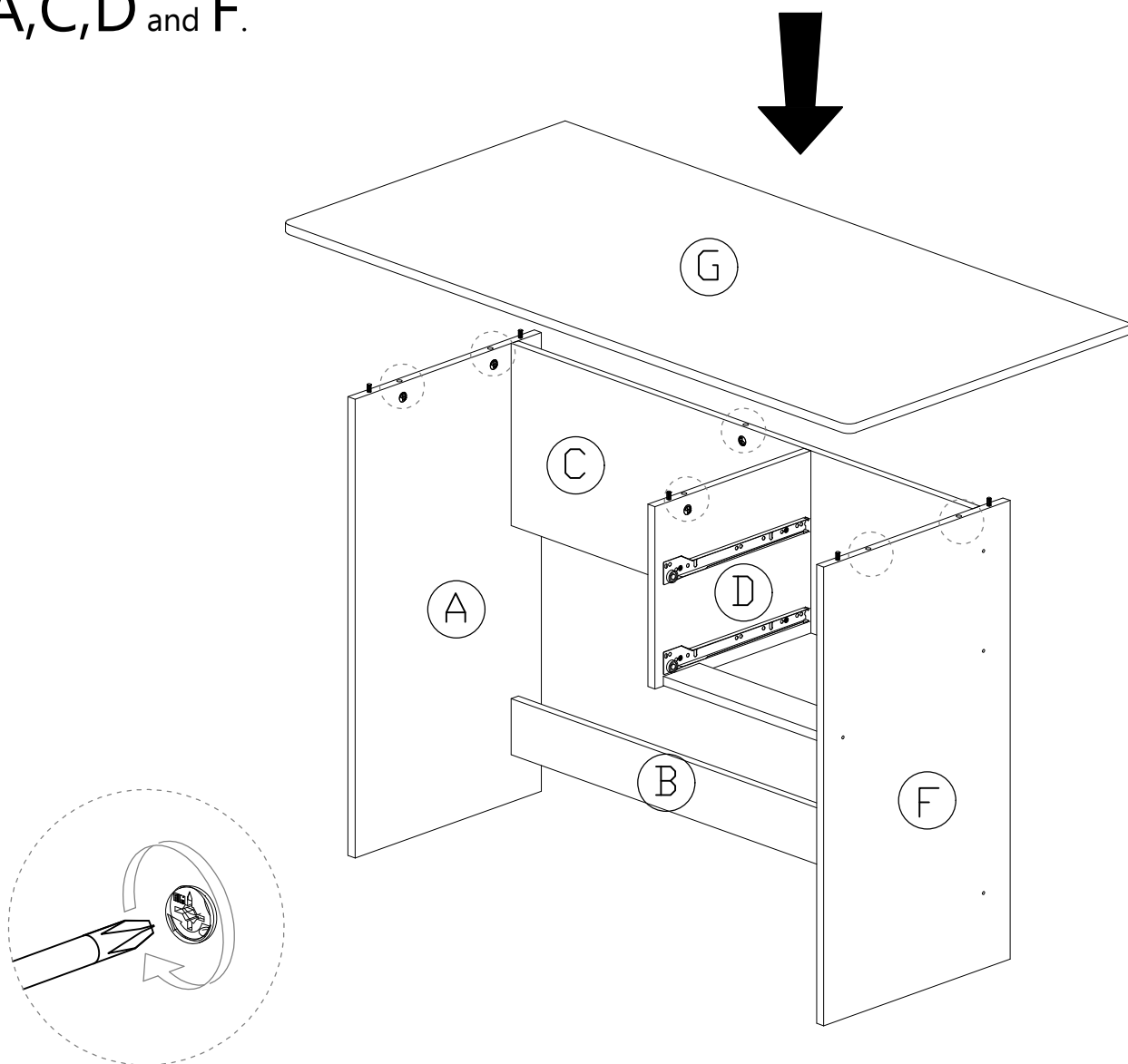

Step 5

A. Insert the mini fix ⑨ (nuts) with the cross arrow mark facing upward and aim to panel **I** & **J** 's top thru holes. (As shown)

B. Insert the PVC dowels ① to panel **I** and **J** 's non-thru holes as shown, using hammer to tap them in.

C. Insert, push down and tighten mini fix screw ⑨, to the hole as shown (Panel **H**)

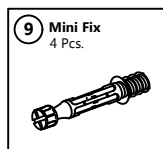
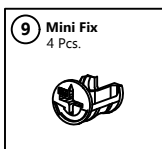
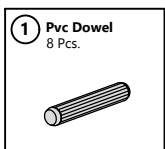
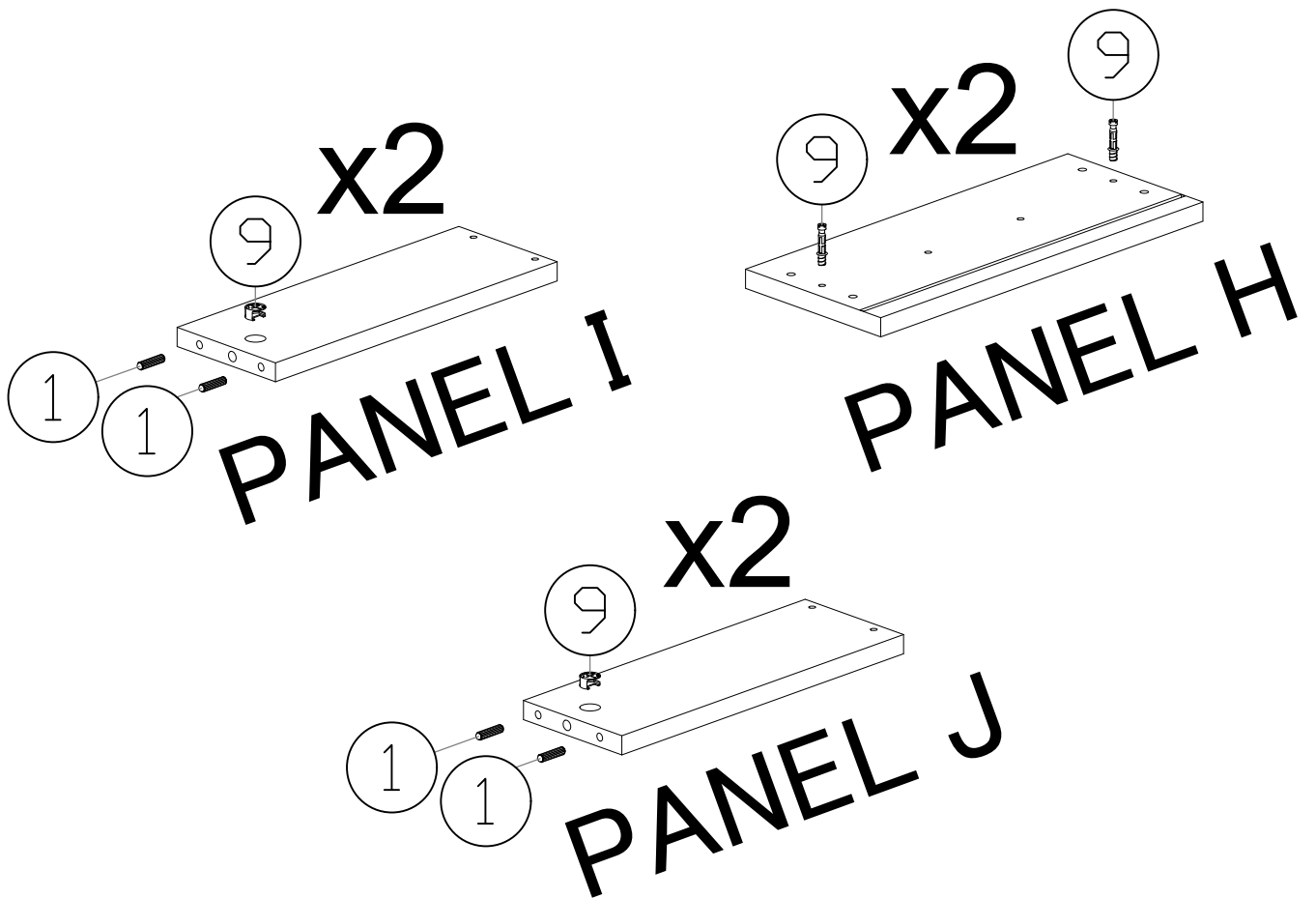

Assembly Of Drawers

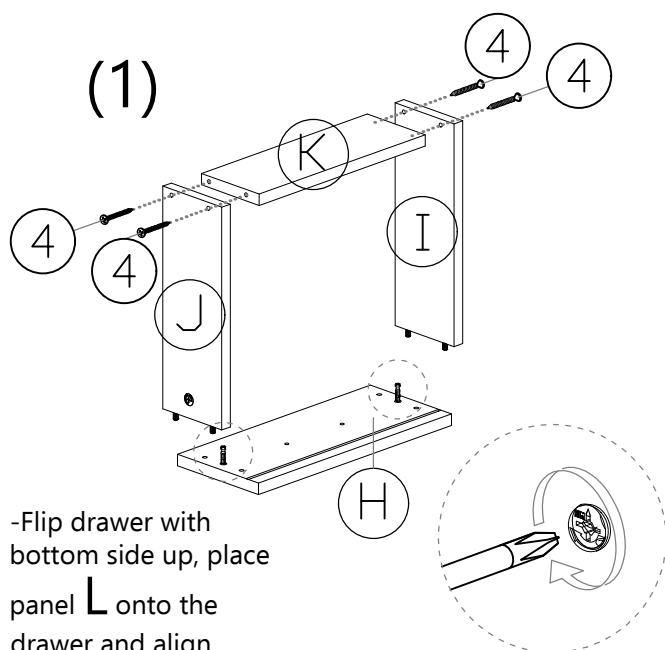

-Flip drawer with bottom side up, place panel L onto the drawer and align properly. Then nail the nails provided with hammer on the border of panel L as shown. The gap between 2 nails is about 100mm.

-After that, place a drawer slide B 13 with the small white roller facing outward and with other end tip touching panel H onto each bottom side (angle) edge of panel I and J. Then tighten 3 screws 3 on each drawer slide B 13 (as shown).

Put the backply stopper 10 onto panel L with the shorter part touching panel H, then tighten it with screw 2.

-Place panel I and J on each side of panel H with Panel I and J's PVC dowel insert to panel H's non-thru hole and Panel H's mini fix screws insert into Panel I and J's thru as shown.

Then tighten mini fix on panel I and J clockwise to lock mini fix up.

-Next tighten screw 4 to panel I and J's upper thru holes to fix up to the panel K.

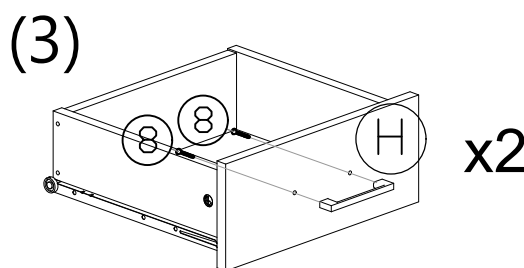
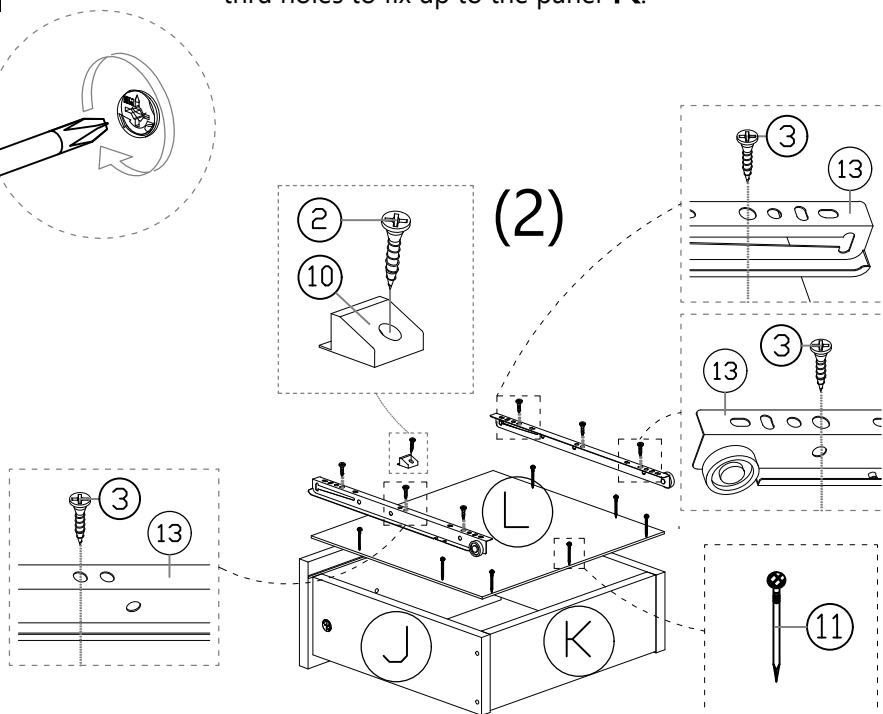

-Flip the drawer over.

-Tighten 2 screw 8 from inner side of panel H into the handle 8 holes.

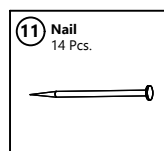
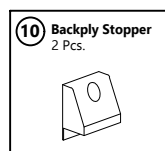
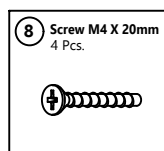
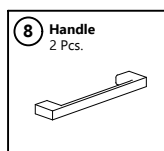
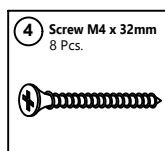
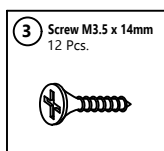
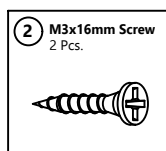

HODEDAH®

Step 6

Take drawers and slide them (the white rollers at drawer slide at both side of drawers are to go into the track of the slides at each side panel.) all the way gently, one drawer by one drawer starting from bottom one.

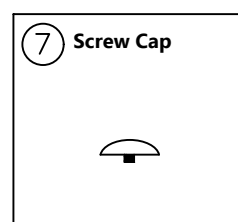
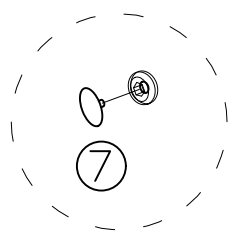
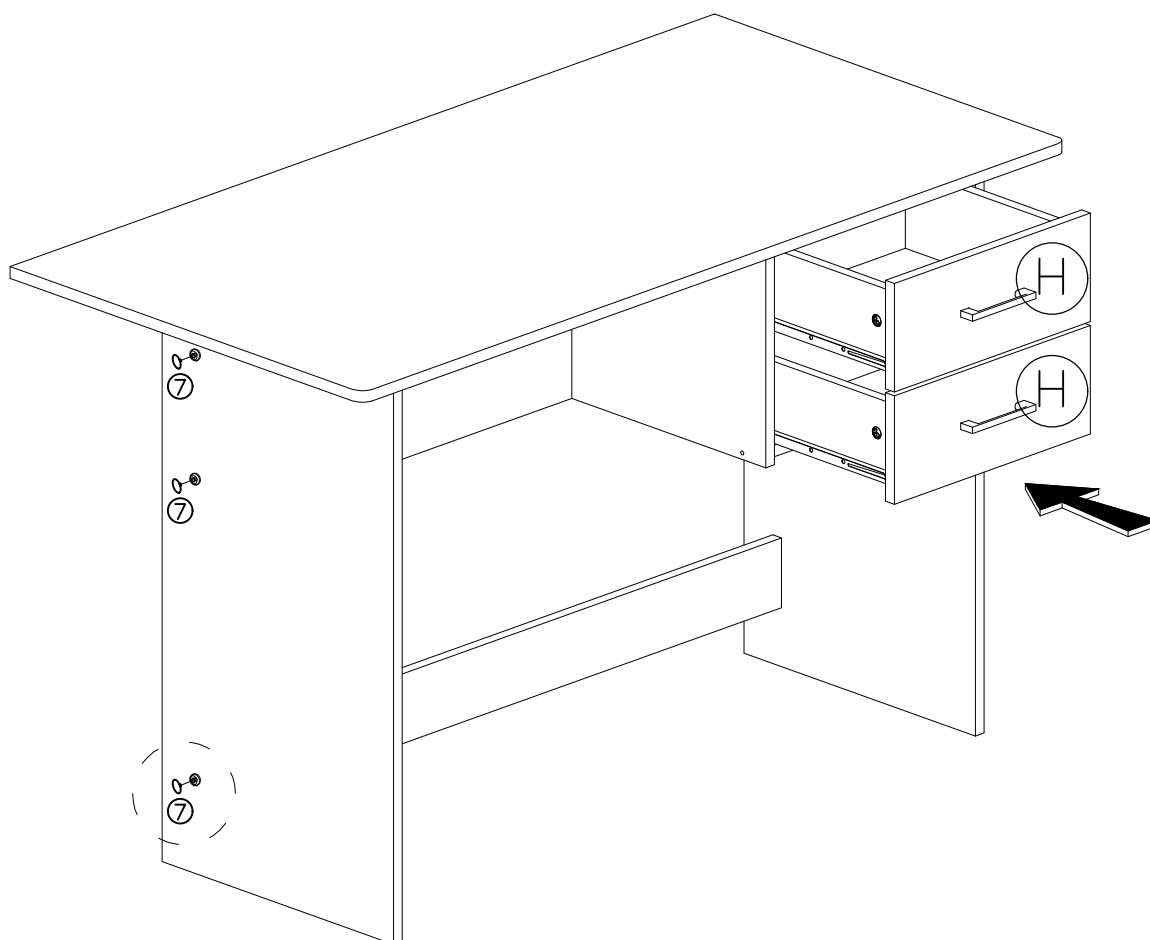

HODEDAH®

Job Complete



Enjoy & Thank you for purchasing from Hodedah!



In the interest of our environment please dispose of all packaging thoughtfully.