

HODEDAH®

# Assembly Instructions

This instruction booklet contains important safety information, please read and keep for future reference.

ITEM # HI4DR-G (MOP-SP)

4 DRAWER CHEST

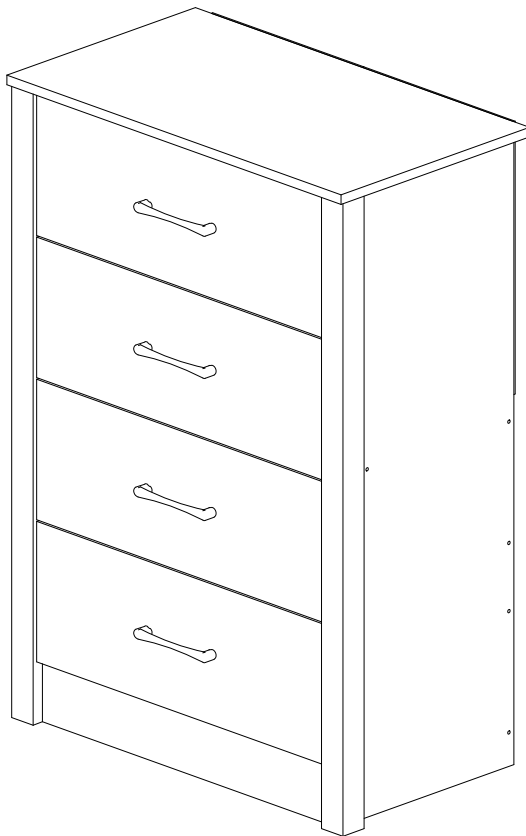

FRONT VIEW

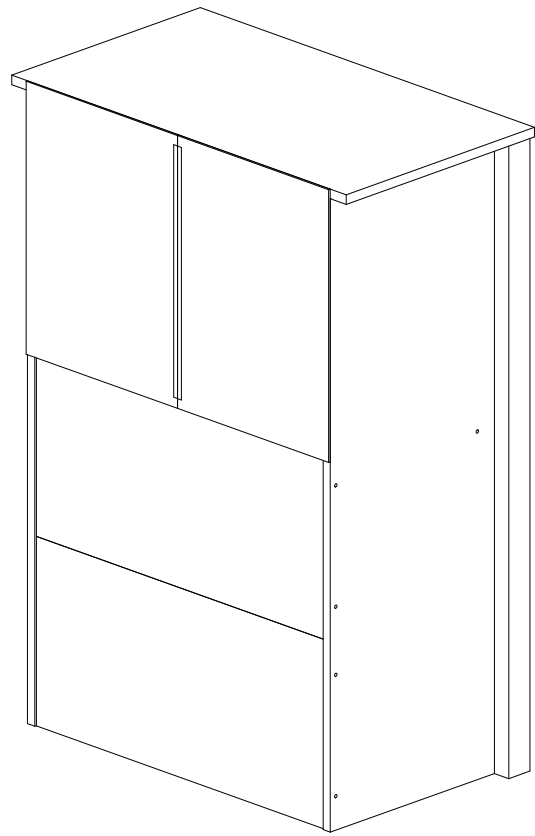

BACK VIEW

**Product Dimensions: Height 40.24" x Width 27.52" x Depth 15.51"**

**Weight Capacity: Large Drawer 25lb. | Small Drawer 20lb.**



## Phone

Mon - Fri | 9:30 am to 5pm EST

**1 - 855 - HODEDAH**

**1 - 855 - 463 -3324**



## Email

Send us an email

**Support@Hodedah.com**



## Website

Visit our website to open a case

**www.Hodedah.com**

## Questions, need parts, we are here to help!

**FOR PROMPT, RELIABLE SERVICE PLEASE HAVE YOUR INSTRUCTION MANUAL READY**



## DO NOT RETURN PRODUCT TO THE STORE

If parts are missing or damaged please contact our customer service team and we will gladly ship your replacement parts FREE of charge within **ONE YEAR** of purchase!

## WARRANTY

Hodedah warrants this product to be free from defects in materials and workmanship and agrees to remedy any such defect. This warranty covers one year from the date of original purchase. This is solely limited to replacement of defective parts and no assembly for labor is included. This warranty does not apply to any product that has been improperly assembled, subjected to misuse, abuse or which has been altered or repaired in any way. To obtain warranty service, original purchaser must present the following; original bill of sale, date of purchase, where the product was purchased and images if applicable. Components replaced warranted through the remainder of the original warranty only. The defective part will be replaced without charge, subject to the terms and conditions described above.

## WARNING

- This product contains small parts, keep away from children.
- This product contains plastic bags, keep away from children.
- Serious or fatal crushing injuries can occur from furniture tip-over. To help prevent this, place heaviest items on the lower shelves and drawers. Do not set heavy objects on top shelves and drawers.
- Never allow children to climb or hang on drawers, shelves and doors.
- Never open more than one drawer at a time.
- The use of tip-over restraints may reduce but not eliminate the risk of tip-over.

# HODEDAH®

- Never open more than one drawer at a time.
- The use of tip-over restranits may reduce but not eliminate the risk of tip-over.

## Let's get started...

### Helpful hints, read before beginning assembly

- Make sure you receive all boxes. If your item is packed in one box, box count will read 1 of 1, likewise if your item is packed in two boxes, box count will read 1 of 2 and second box will read 2 of 2.
- Read each step carefully. It is very important that each step is performed in the correct order. If these steps are not followed in sequence, assembly difficulties will occur.
- Work in a spacious level area, preferably carpet, near the place the unit will be used.
- **DO NO USE** power tools to assemble your furniture, it will strip and damage parts.
- Your package should include the following hardware and parts. Parts are labeled or stamped on the raw edge. Please inspect contents to ensure you have received all components. **If you are missing any hardware or parts please contact customer service right away before assembly.**

## Assembly Tools Required (not supplied)



Hammer

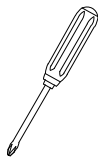

Phillips Screwdriver

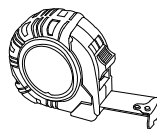

Tape Measure

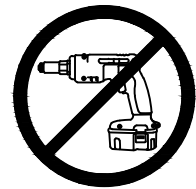











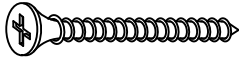

No Power Tools Needed

---



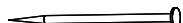

## Product Care and Maintenance

- Wipe clean with dry soft cloth, never use chemicals or cleaning products they will damage the finish.
- Avoid placing your furniture in direct sunlight, as sunlight causes fading.
- Never push, drag or pull your furniture, to move to a new location carefully with two or more people carry the unit to its new location.
- Avoid extreme changes in temperature by arranging furniture away from radiators, heat and air vents and air conditioning units.

# Hardware List

<p><b>1</b></p>  <p>Screw M6 x 40mm</p>  <p>Pvc Cap</p>	<p><b>QTY</b></p> <input type="checkbox"/> 10 Pcs 10 Pcs	<p><b>2</b></p>  <p>Screw M4 x 32mm</p>	<p><b>QTY</b></p> <input type="checkbox"/> 20 Pcs	<p><b>3</b></p>  <p>Screw M3.5 x 14mm *For # 13 Drawer Slides</p>	<p><b>QTY</b></p> <input type="checkbox"/> 32 Pcs
<p><b>5</b></p>   <p>Mini Fix</p>  <p>Pvc Cap</p>	<p><b>QTY</b></p> <input type="checkbox"/> 6 Sets 6 Pcs	<p><b>6</b></p>  <p>L Bracket</p>  <p>Screw M6.3 x 13mm</p>	<p><b>QTY</b></p> <input type="checkbox"/> 16 Pcs 32 Pcs	<p><b>7</b></p>  <p>Pvc Dowel</p>	<p><b>QTY</b></p> <input type="checkbox"/> 42 Pcs
<p><b>8</b></p>  <p>H-Profile</p>	<p><b>QTY</b></p> <input type="checkbox"/> 1 Pc	<p><b>9</b></p>  <p>Nail</p>	<p><b>QTY</b></p> <input type="checkbox"/> 70 Pcs	<p><b>10</b></p>  <p>Allen Key</p>	<p><b>QTY</b></p> <input type="checkbox"/> 1 Pc
<p><b>11</b></p>  <p>Screw M6.2 x 10mm *For # 12 Drawer Slides</p>	<p><b>QTY</b></p> <input type="checkbox"/> 16 Pcs				

# Accessories

 <p>* Fix On Side Panels (A)</p> <p>* Fix On Side Panels (F)</p>	<p><b>12</b></p> <p><b>Drawer Slide - A</b></p> <p>*Fix On Side Panels (A) &amp; (F)</p>	<p><b>QTY</b></p> <p><input type="checkbox"/></p> <p>4 Sets</p>
 <p>* Fix On Drawer Side Panels (I)</p> <p>* Fix On Drawer Side Panels (J)</p>	<p><b>13</b></p> <p><b>Drawer Slide - B</b></p> <p>*Fix On Side Panels (I) &amp; (J)</p>	<p><b>QTY</b></p> <p><input type="checkbox"/></p> <p>4 Sets</p>
<p><b>4</b></p>  <p><b>Handle</b></p>  <p><b>Screw M4 X 30mm</b></p>	<p><b>QTY</b></p> <p><input type="checkbox"/></p> <p>4 Pcs</p> <p><input type="checkbox"/></p> <p>8 Pcs</p>	

## Important

1. Before you throw the package, please use the Check Box to identify the parts and hardware to ensure that you have everything you need.
2. Check and measure the bolts before applying them to parts.
3. Do not completely tighten all hardware until the entire assembly is complete, unless indicated otherwise.

# Parts List

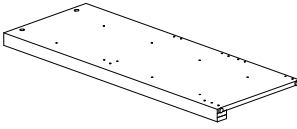
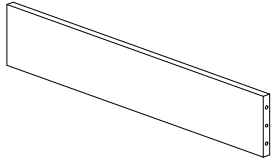
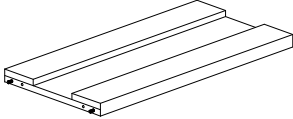
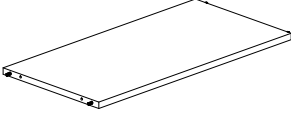
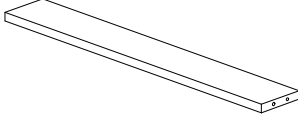
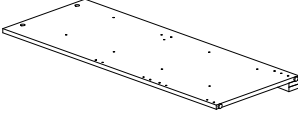
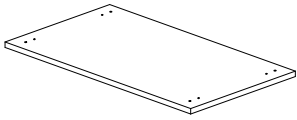
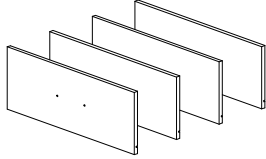
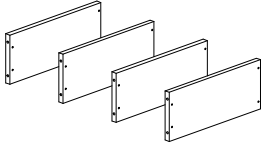
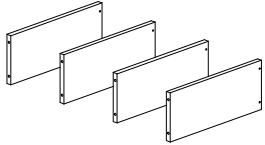
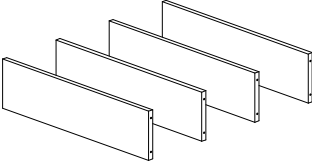
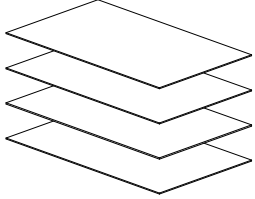
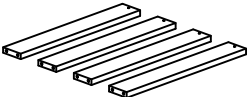
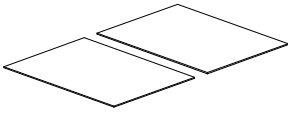
<p><b>A</b> Left Side Panel 1003x 387 x 15mm</p> 	<p><b>QTY</b>  1 Pc</p>	<p><b>B</b> Kick Panel (Front) 603 x 105 x 15mm</p> 	<p><b>QTY</b>  1 Pc</p>	<p><b>C</b> Kick Panel (Back) &amp; Back Strengthening Panel 603 x 300 x 15mm</p> 	<p><b>QTY</b>  1 Pc</p>
<p><b>D</b> Kick Panel (Back) &amp; Back Strengthening Panel 603 x 300 x 15mm</p> 	<p><b>QTY</b>  1 Pc</p>	<p><b>E</b> Front Strengthening Panel 603 x 89 x 15mm</p> 	<p><b>QTY</b>  1 Pc</p>	<p><b>F</b> Right Side Panel 1003x 387 x 15mm</p> 	<p><b>QTY</b>  1 Pc</p>
<p><b>G</b> Top Panel 699 x 394 x 15 mm</p> 	<p><b>QTY</b>  1 Pc</p>	<p><b>H</b> Drawer Front Panels 597 x 222 x 15mm</p> 	<p><b>QTY</b>  4 Pcs</p>	<p><b>I</b> Drawer - Left Side Panels 338 x 140 x 15mm</p> 	<p><b>QTY</b>  4 Pcs</p>
<p><b>J</b> Drawer - Right Side Panels 338 x 140 x 15mm</p> 	<p><b>QTY</b>  4 Pcs</p>	<p><b>K</b> Drawer End Panels 549 x 140 x 15mm</p> 	<p><b>QTY</b>  4 Pcs</p>	<p><b>L</b> Drawer Base Panels 577 x 342 x 3mm</p> 	<p><b>QTY</b>  4 Pcs</p>
<p><b>M</b> Drawer Support Panel 338 x 51 x 15mm</p> 	<p><b>QTY</b>  4 Pcs</p>	<p><b>Back Panels</b> 432 x 316 x 3mm</p> 	<p><b>QTY</b>  2 Pcs</p>		

# The Breakdown

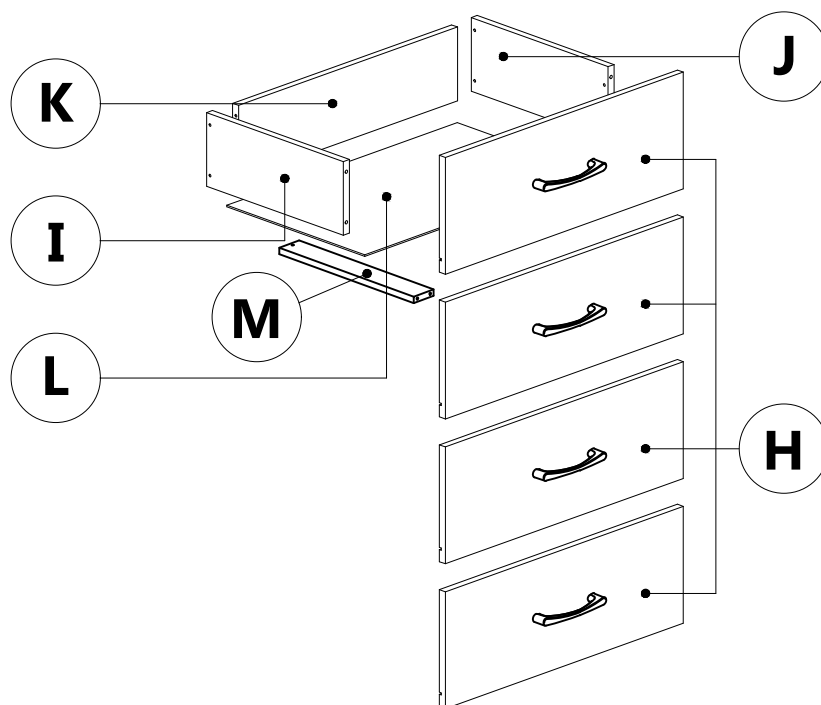
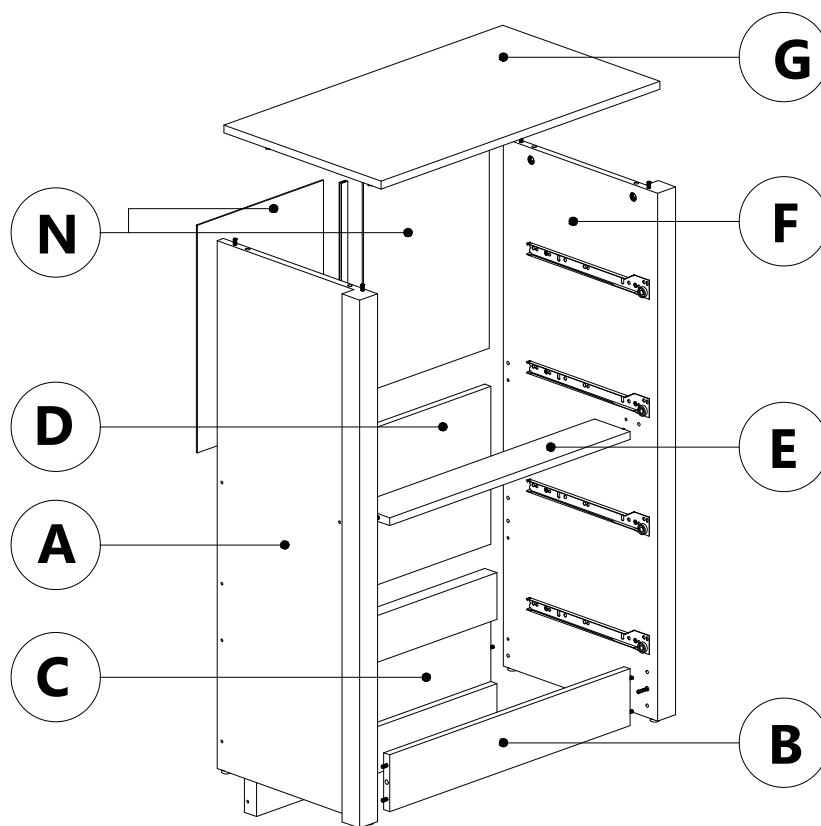

## Pre - Assembly

1. Insert the pvc dowels ⑦ to panels **A** and **F** 's non-thru holes as shown, using hammer to gently tap them in.
2. Place the drawer slide A ⑫ onto the 2 holes area shown at left side panels **A** and **F**. Then tighten it with 2 screws ⑪ and 1 screw ③. Do the same for the 3 other slide A ⑫.
3. Nail Protection Nail ⑧, provided with hammer onto the bottom edge of panels **A** and **F** as shown.
4. Insert the mini fix ⑤ (nuts) with the cross arrow mark facing upward and aim to panels **A** and **F** 's top thru holes. (As shown)
5. Insert, push down and tighten mini fix screw ⑤ to the hole at panels **A** and **F** as shown.

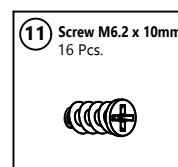
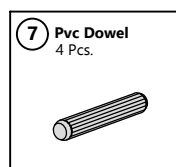
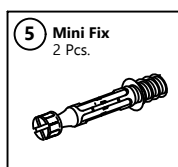
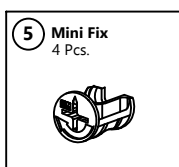
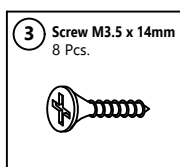
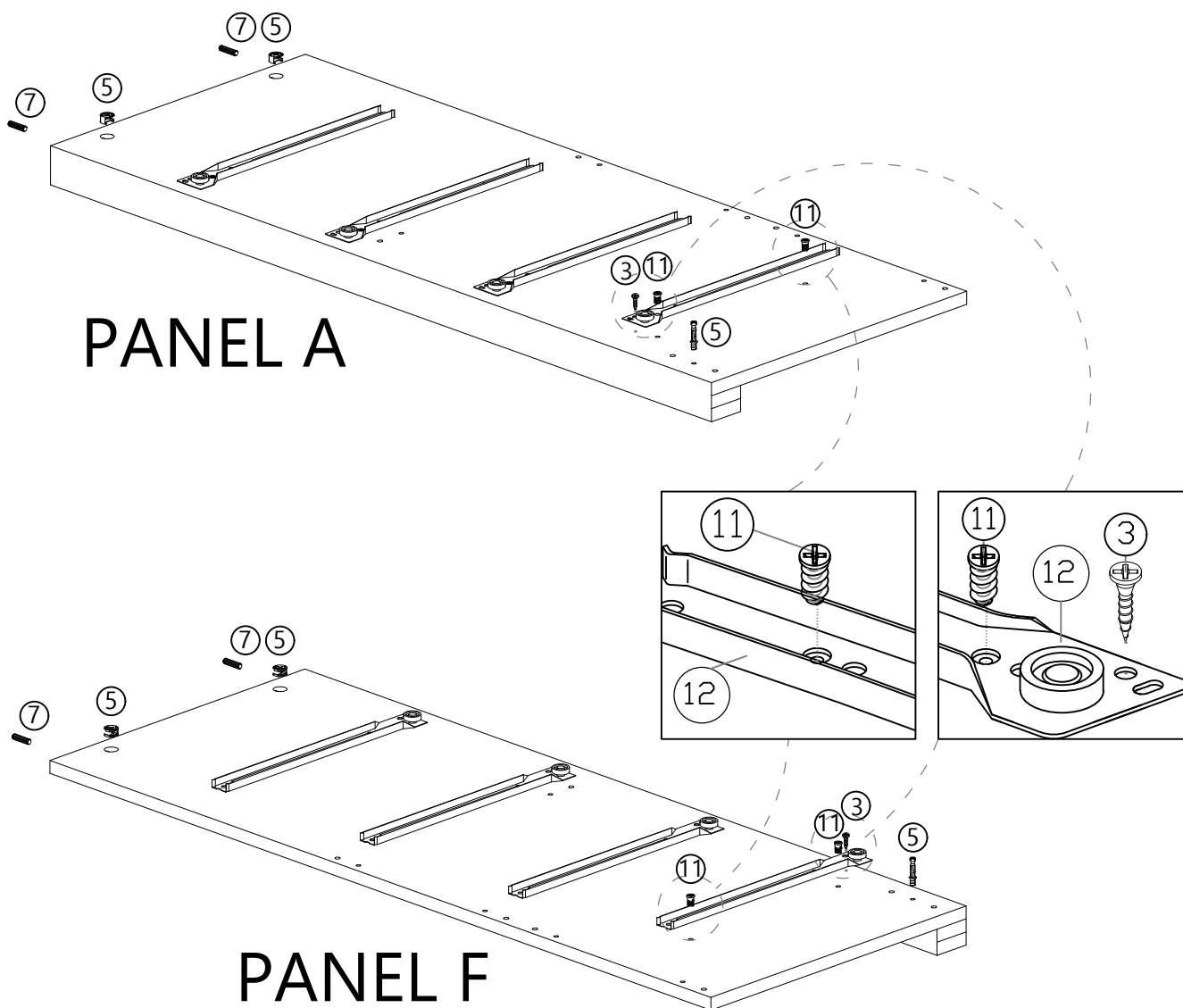



## Pre - Assembly

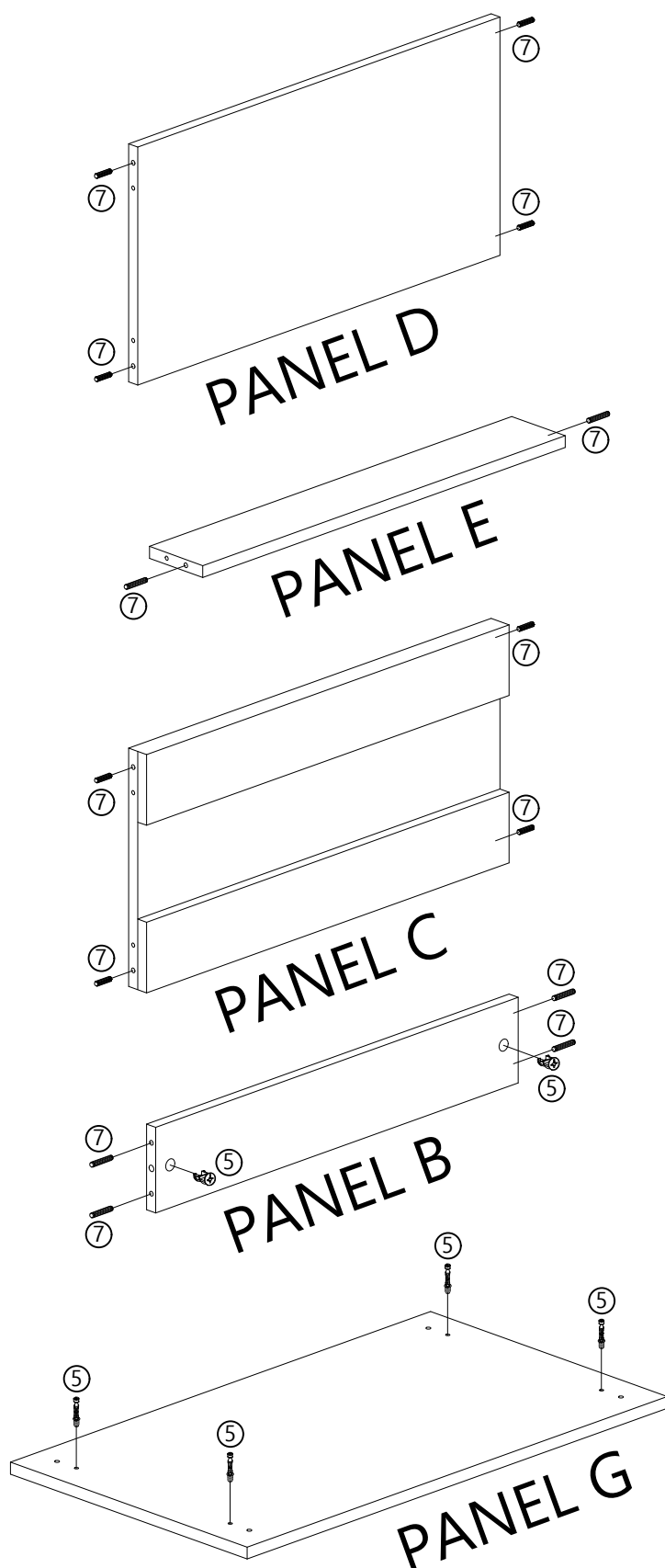

Insert the pvc dowels ⑦ to both end of the panels B,C,D and E. Using hammer to gently tap them in.

Insert the mini fix ⑤(nuts) with the cross arrow facing outward and aim to panel B's thru hole.

Insert, push down and tighten mini fix screw ⑤, to the non-thru hole of the panel G as shown, 4pcs.

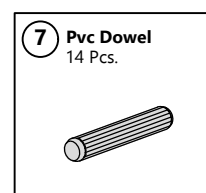
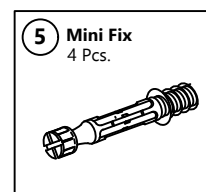
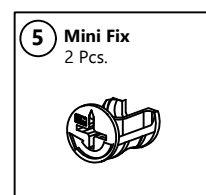

## Assembly Of Drawers : 4 DRAWERS

Place L bracket and ensure its shorter part contact on panels **I** and **J** 's non-thru holes as shown, then tighten them with screws **6**.

Insert the PVC dowels **7** to end of the panels **I** to **J**. Using hammer to gently tap them in.

Place panels **I** and **J** on each side of panel **K** as shown.

Then tighten screw **2** to panels **I** and **J** 's upper thru holes to fix them onto panel **K**. **DRAWER G**

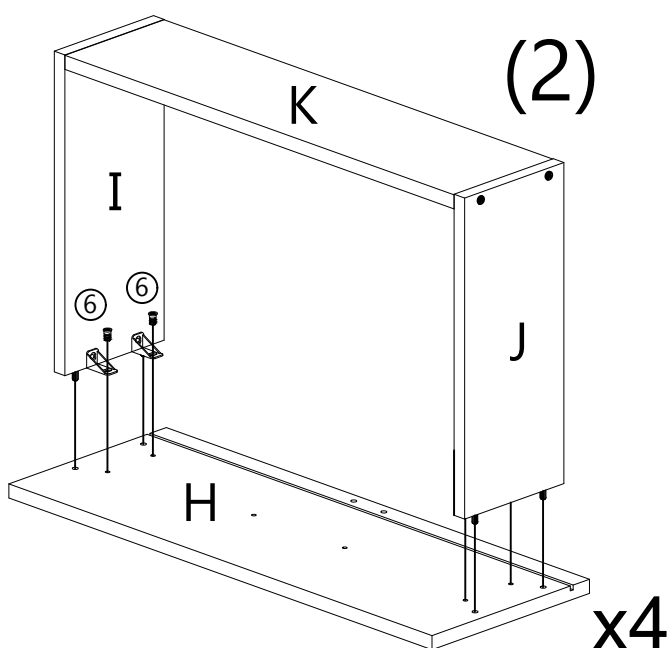
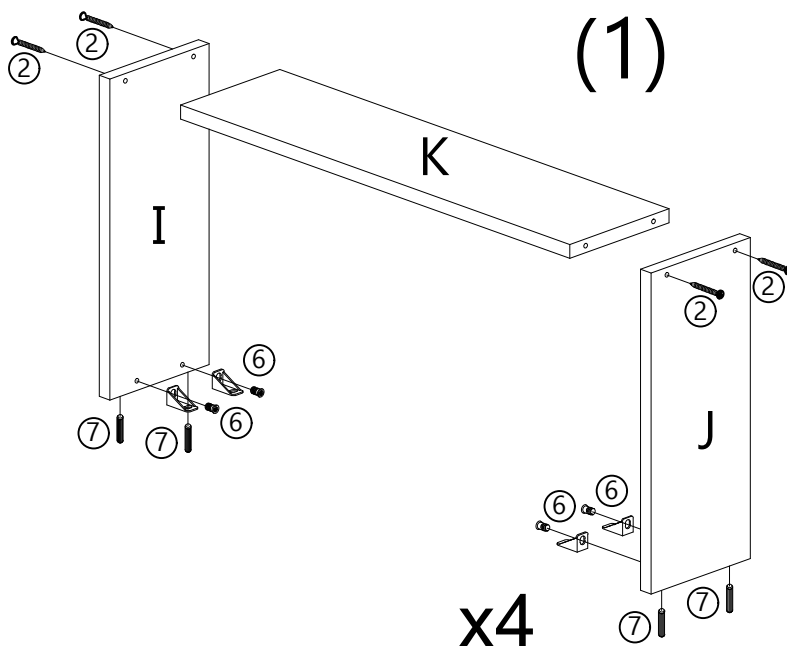

Inserting panels **I** and **J** 's lower PVC dowels onto the outer non-thru holes at panel **H**. Tighten 4 screws **6** from 4 L bracket's thru hole to 4 non-thru holes of panel **H**.

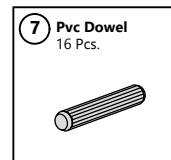
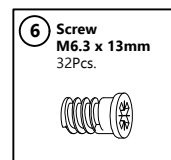
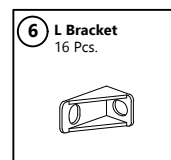
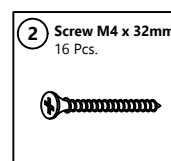

# Assembly Of Drawers : 4 DRAWERS

Flip drawer with bottom side up, place panel L onto panels I, J and K and insert panel L to groove of panel H.

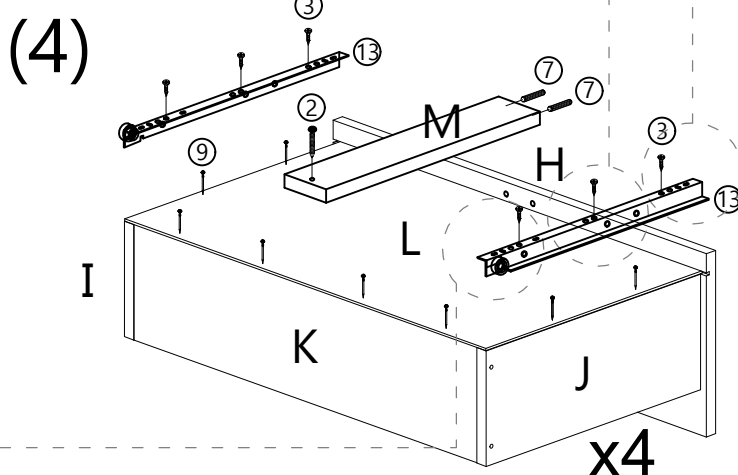
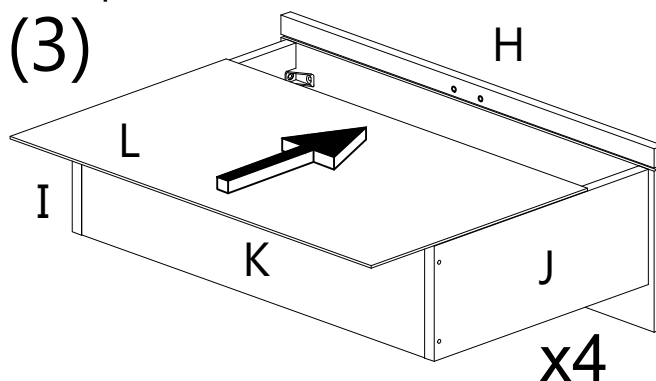
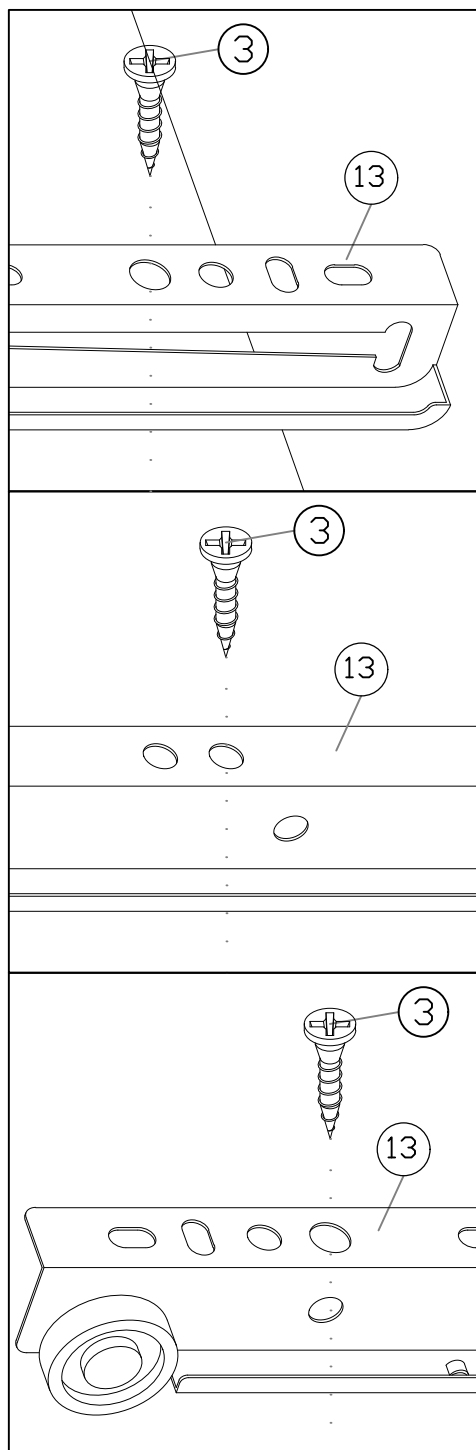

Then nail the nails provided with hammer on the border of panel L as shown. The gap between 2 nails should be about 100mm.

After that, place drawer slides B (13) with the small white roller facing outward and with other end tip touching panel H onto each bottom side (angle) edge of panels I and J.

Then tighten 3 screws (3) on each drawer slide B (13) (as shown).

Insert the pvc dowels (7) to end of the panels M. Using hammer to gently tap them in.

Place and fix Panel M onto Panel H by inserting the dowels onto the non-thru holes at Panel H.

Then tighten screw (2) to panels L's thru holes to fix them onto panels L and K.

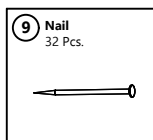
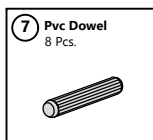
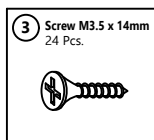
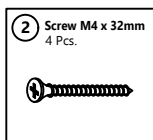

# Assembly Of Drawers : 4 DRAWERS

(4)

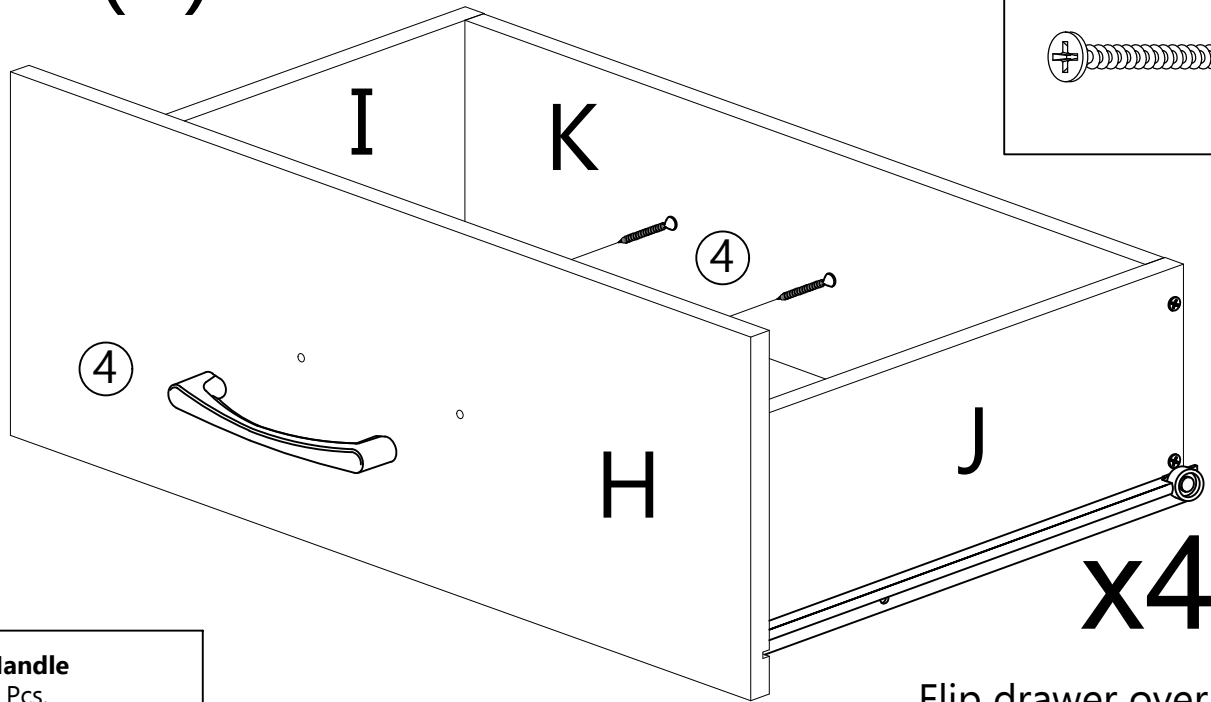

4 Screw  
M4 X 30mm  
8Pcs.

4 Handle  
4 Pcs.

Flip drawer over with bottom side down, tighten 2 screw ④ from inner side of panel H into the handle ④'s holes.

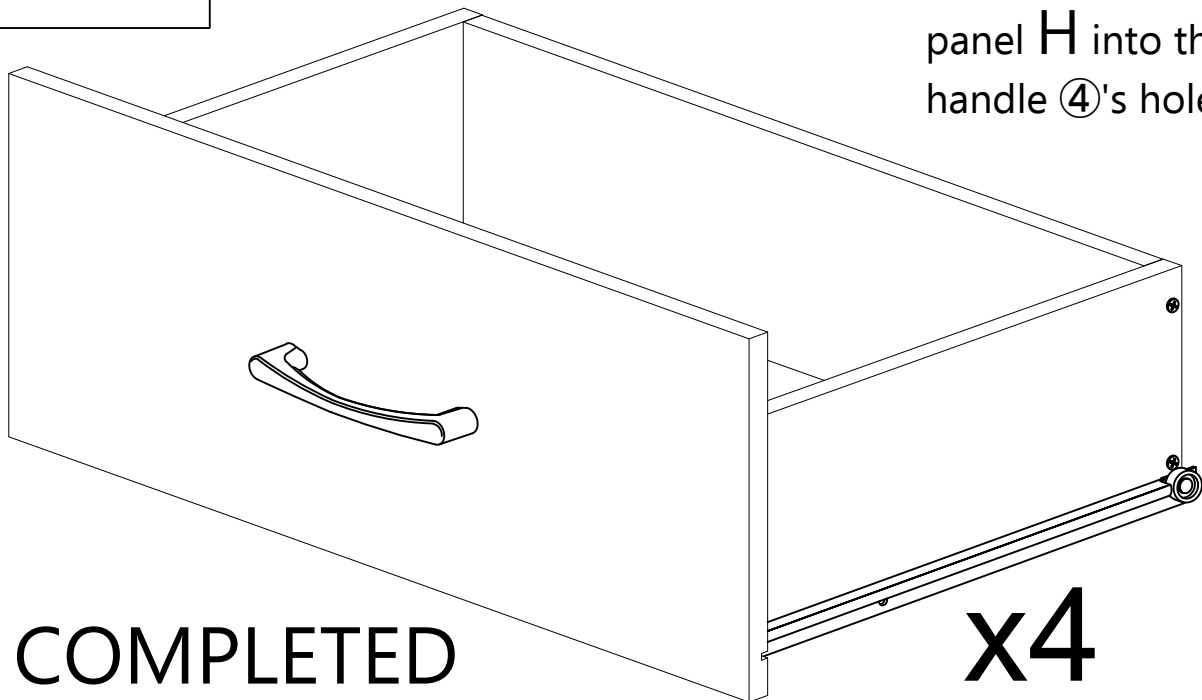

COMPLETED

x4

## Step 1

- \* Place and fix Panels B,C,D,E onto Panel A by inserting the (Left) dowels onto the non-thru holes at Panel A.
- \* Using allen key ⑩ to tighten screws ① from the 5 thru holes of panel A, one by one.
- \* Tighten mini fix clockwise to lock mini fix up.

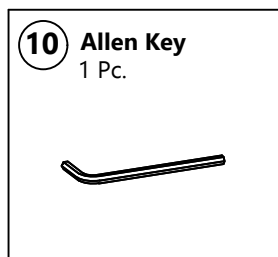
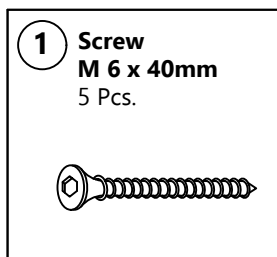
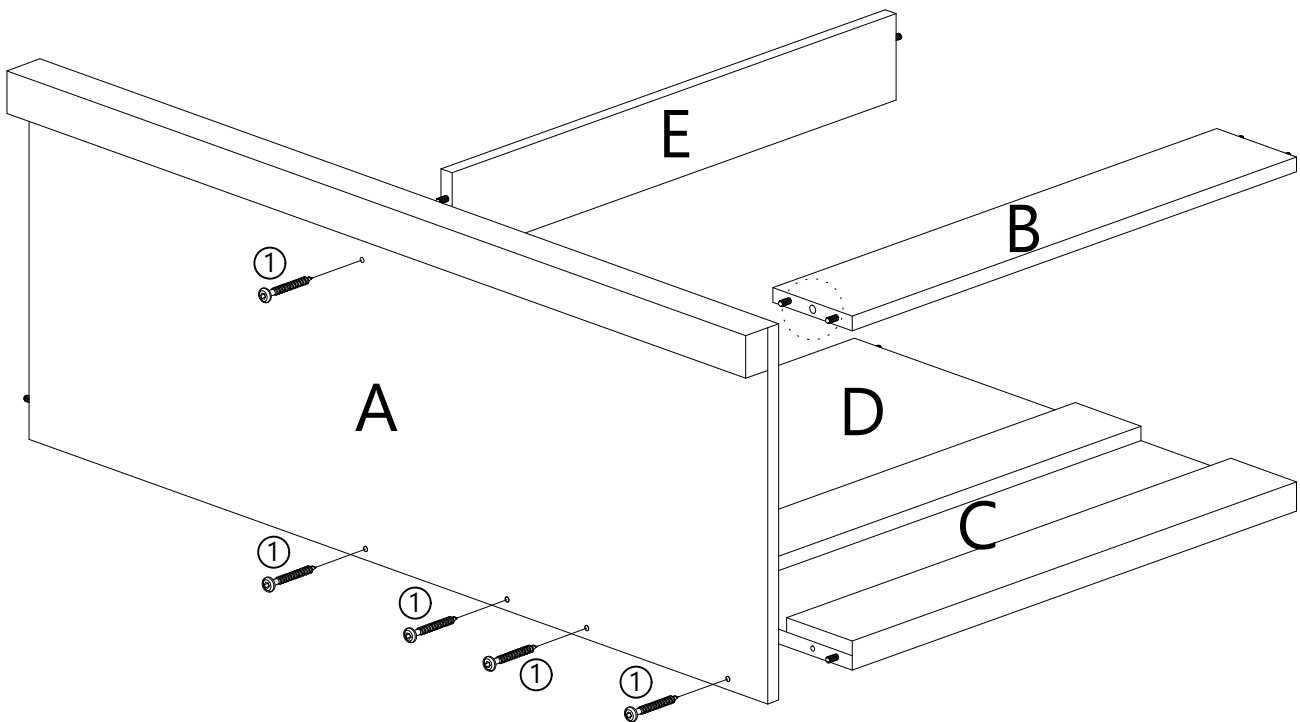
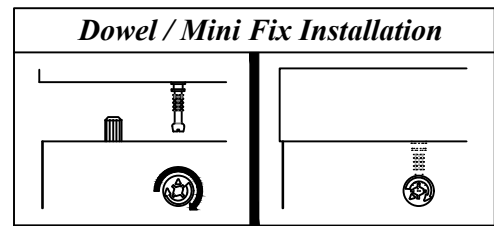

## Step 2

\* Place and fix Panels **B,C,D,E** onto Panel **F** by pushing and slotting the (Right) dowels onto the non-thru holes at Panel **F**.

\* Using allen key ⑩ to tighten screws ① from the 5 thru holes of panel **F**, one by one.

\* Tighten mini fix clockwise to lock mini fix up.

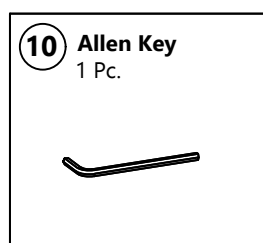
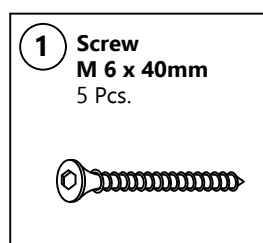
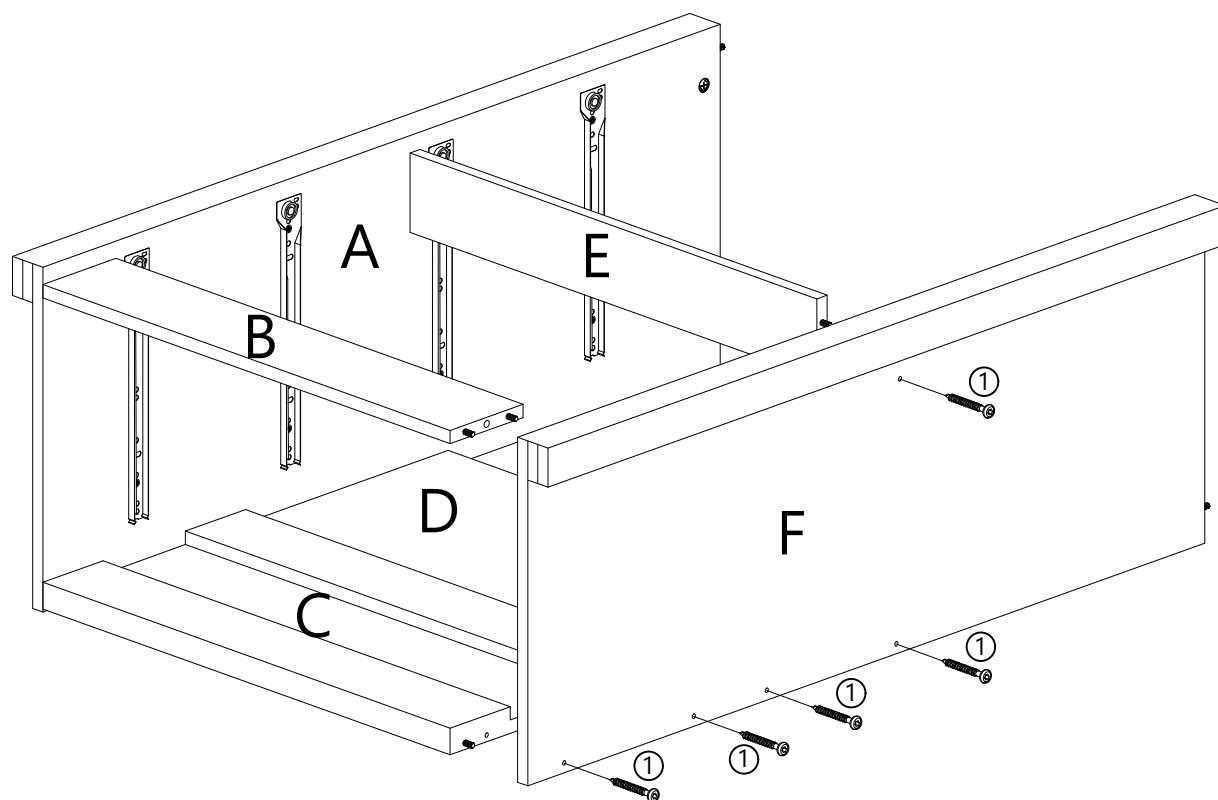
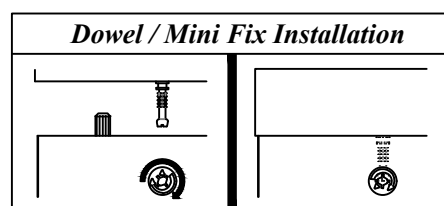

## Step 3

Place and fix panel **G** onto panels **A** and panel **F**, and align properly by inserting the 4 (down) mini fix screws ⑤ onto the L-thru holes at top edge of panel **A** and **F**. At the same time, inserting panel **A** and panel **F**'s upside dowels going onto panel **G**'s non-thru holes.

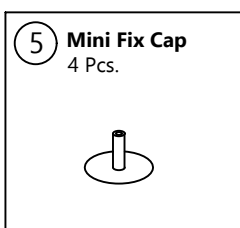
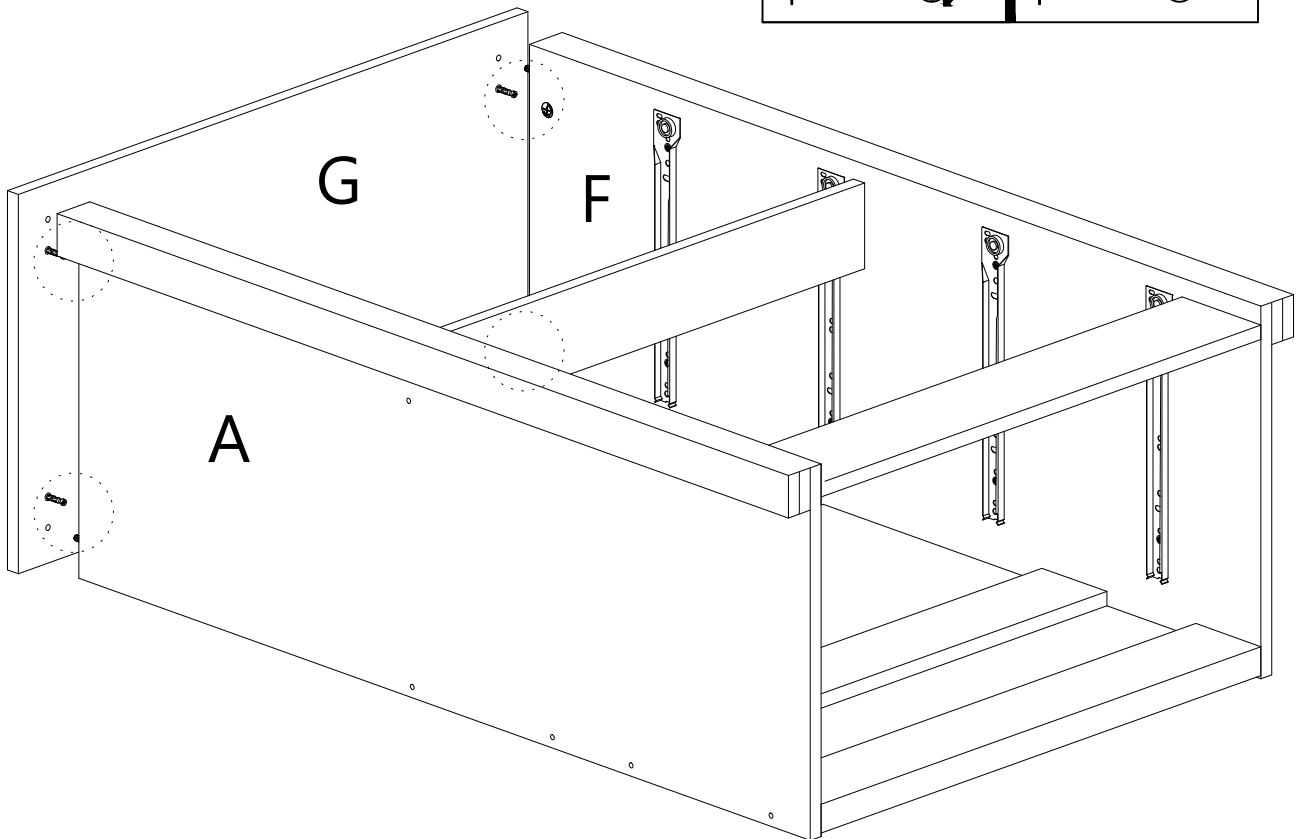
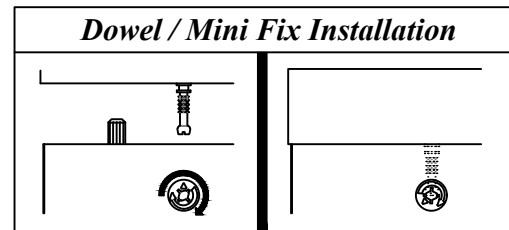

\*Then, tighten mini fix ⑤ clockwise to lock the mini fix up for tightening panel **G** up. Cover 4 mini fix caps provided by pushing the cover's stem onto the hole of mini fix nut on upper side of panel **A** and **F**.

## Step 4

Lay the main unit at face down position, Place the back Panels **N** onto the back of the main unit, and join the 2 panels **N** together with H-profile by slotting one side each of panels **N** into the track of H-profile. Then align them properly for nailing.

Then use hammer to nail the nails one by one and at center of 4 side edges. Gap between 2 nails should be about 100mm for all.

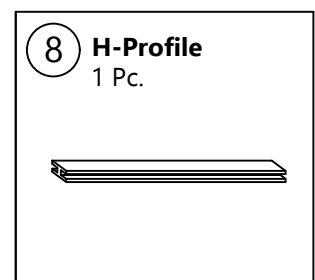
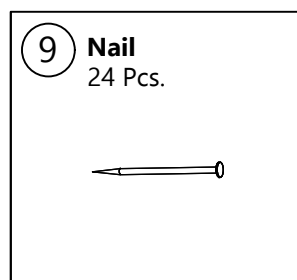
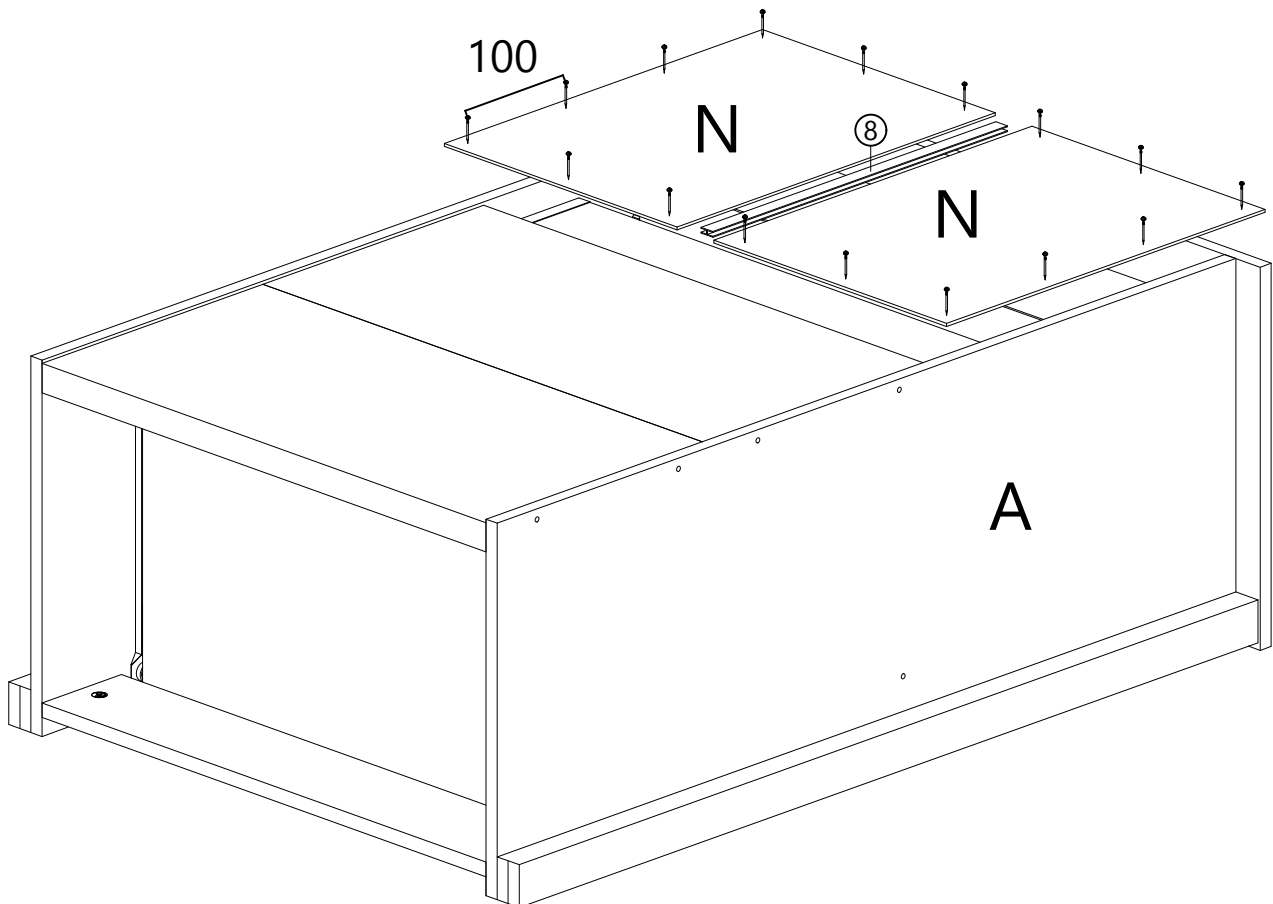



## Step 5

- \* Lift up the main unit carefully and let it stand up properly.
- \* Cover all the screws ① 's head with the PVC cap provided by pushing the cover's stem onto the hole of screw head one by one for all screws on panels **A** and **F**.
- \* Take all drawers , and slide them (the white rollers at drawer slide at both side of drawers are to go into the track of the slides at each side panel.) all the way gently, one drawer by one drawer starting from bottom one

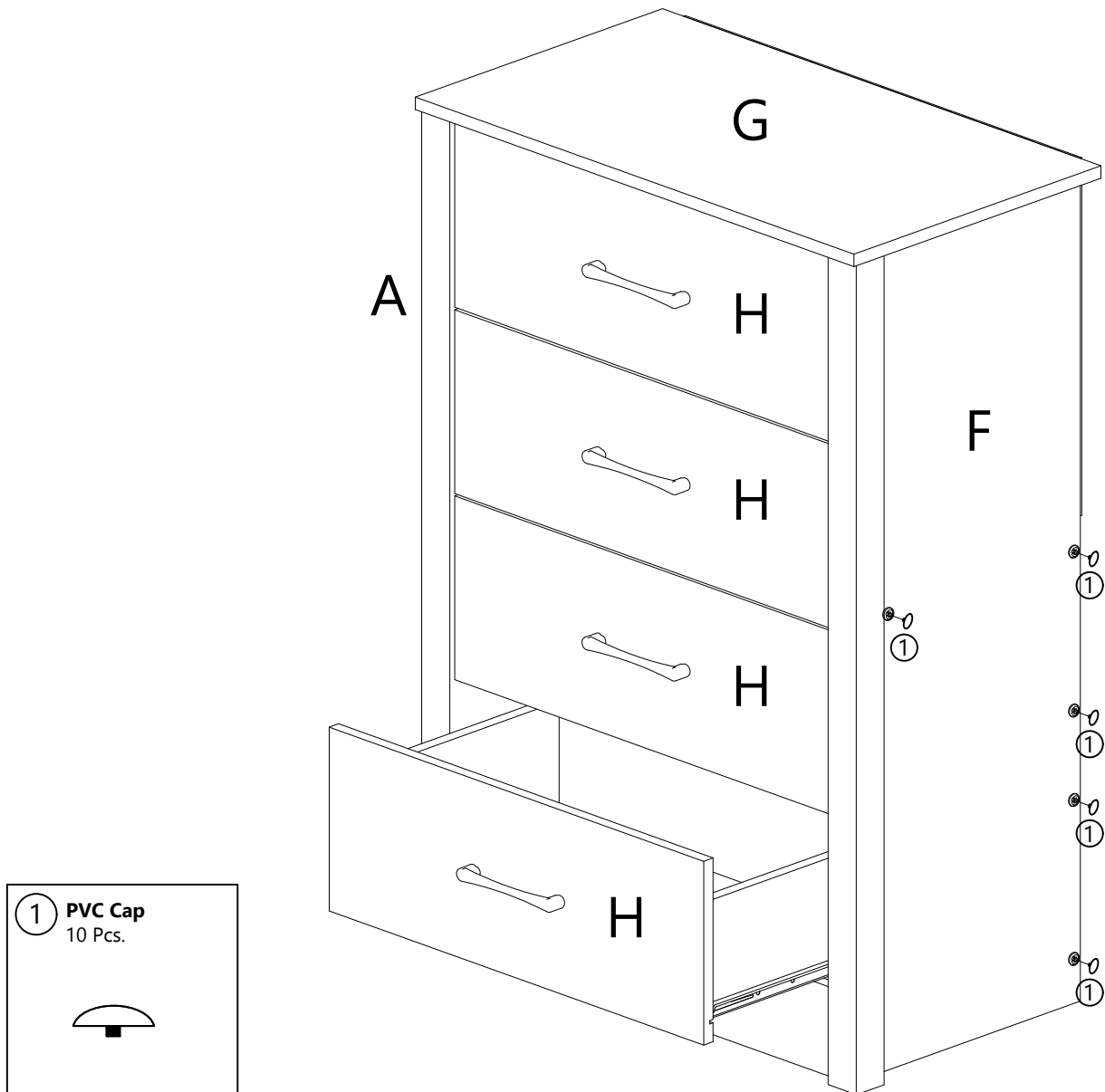

## FITTING OF ANTI-TIP SAFETY STRAP

### STEP 1:

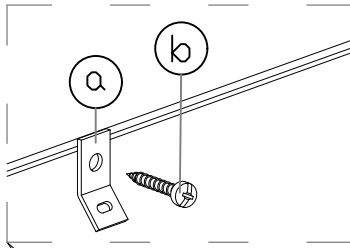

- Attach the mounting bracket (a) to the furniture in the solid part below the top panel a few inches away from the side of the unit.
- Screw (b) through the smallest hole of (a).

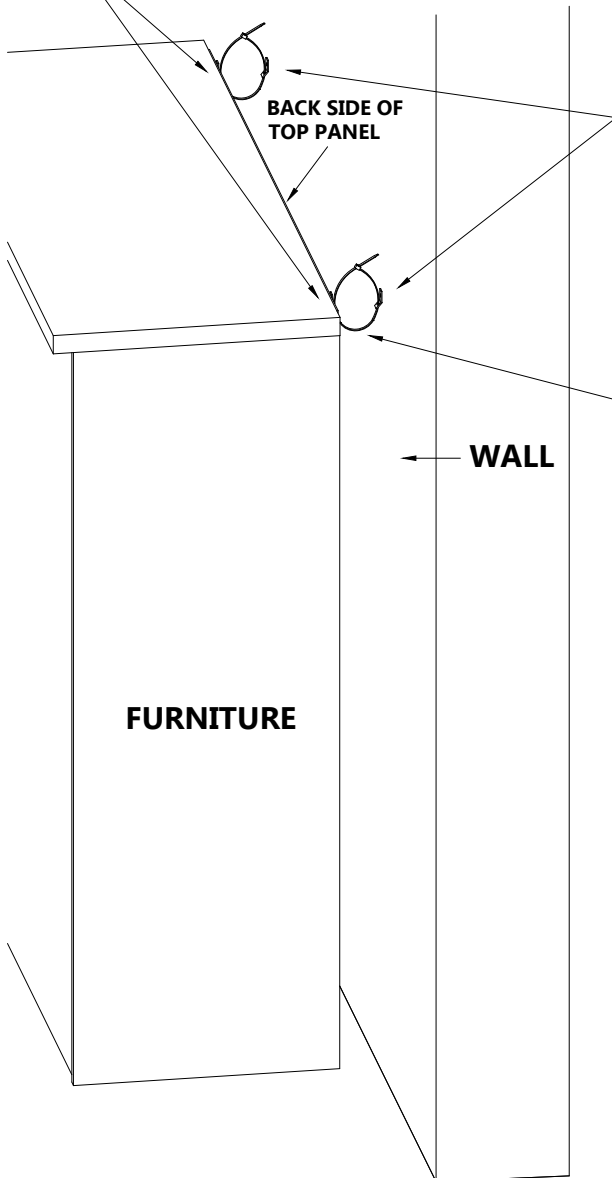

### STEP 2:

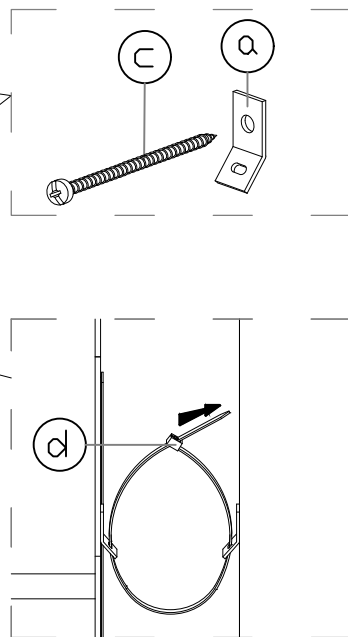

- Locate a stud in the wall behind the unit, does not have to be centered.
- Place the other mounting bracket (a) on the wall stud 2 inches below the mounting bracket secured to the back of your unit.
- Attach to the wall stud using (c) through the smaller hole of (a).

### STEP 3:

- Repeat the same step a few inches away from the other side of the unit.
- Place the furniture into position so both mounting brackets are vertically in line.
- Lace the end of the restraint strap through the larger holes in each mounting bracket.
- Secure the straps and lock into place.

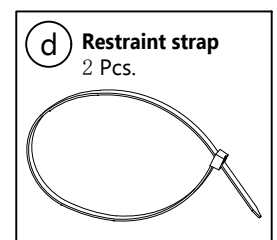
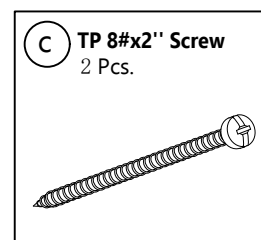
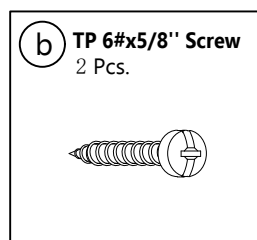
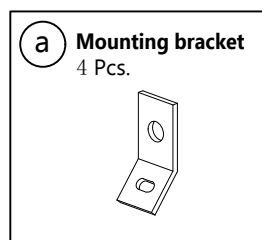

HODEDAH®

# Completion



Enjoy & Thank you for purchasing from Hodedah!

